

W I N T E R

2 0 2 0

# COLLECTION

PRE-ORDER  
CATALOG

STAY SALTY



WWW.MANERA.COM

# CONT ENT

2 0 2 0  
C O L L

**4**

## INTRO

4 OUR STORY

**14**

## NEOPRENE

6 OVERVIEW

8 METEOR MAGMA

- . 8 Key features
- . 10 Men
- . 13 Key features back zip
- . 14 Women

16 METEOR X10D

- . 16 Key features
- . 18 Men
- . 22 Women

26 THICKNESS REPARTITION

**28**

## HARNESSES

28 OVERVIEW

30 ECLIPSE

- . 30 Key features
- . 33 Range

34 EXO

- . 34 Key features
- . 37 Range

38 UNION

- . 38 Key features
- . 41 Range

42 ACCESSORIES

HARNESS

# 44

## BOARDBAGS

### 44 OVERVIEW

46 BOARDBAGS

52 FOILBAGS

56 TRAVELBAGS

59 BOARD SOCKS

# 60

## ACCESSORIES

### 60 OVERVIEW

62 TECHNICAL ACCESSORIES

- . 62 Blizzard jacket
- . 64 Impact vest

66 NEOPRENE ACCESSORIES

- . 67 Hood
- . 67 Glove

68 ACCESSORIES

- . 69 Poncho
- . 69 Car seat cover
- . 69 Magic wax
- . 70 Caps

# 72

## APPAREL

### 72 OVERVIEW



S

T

A

Y

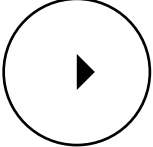
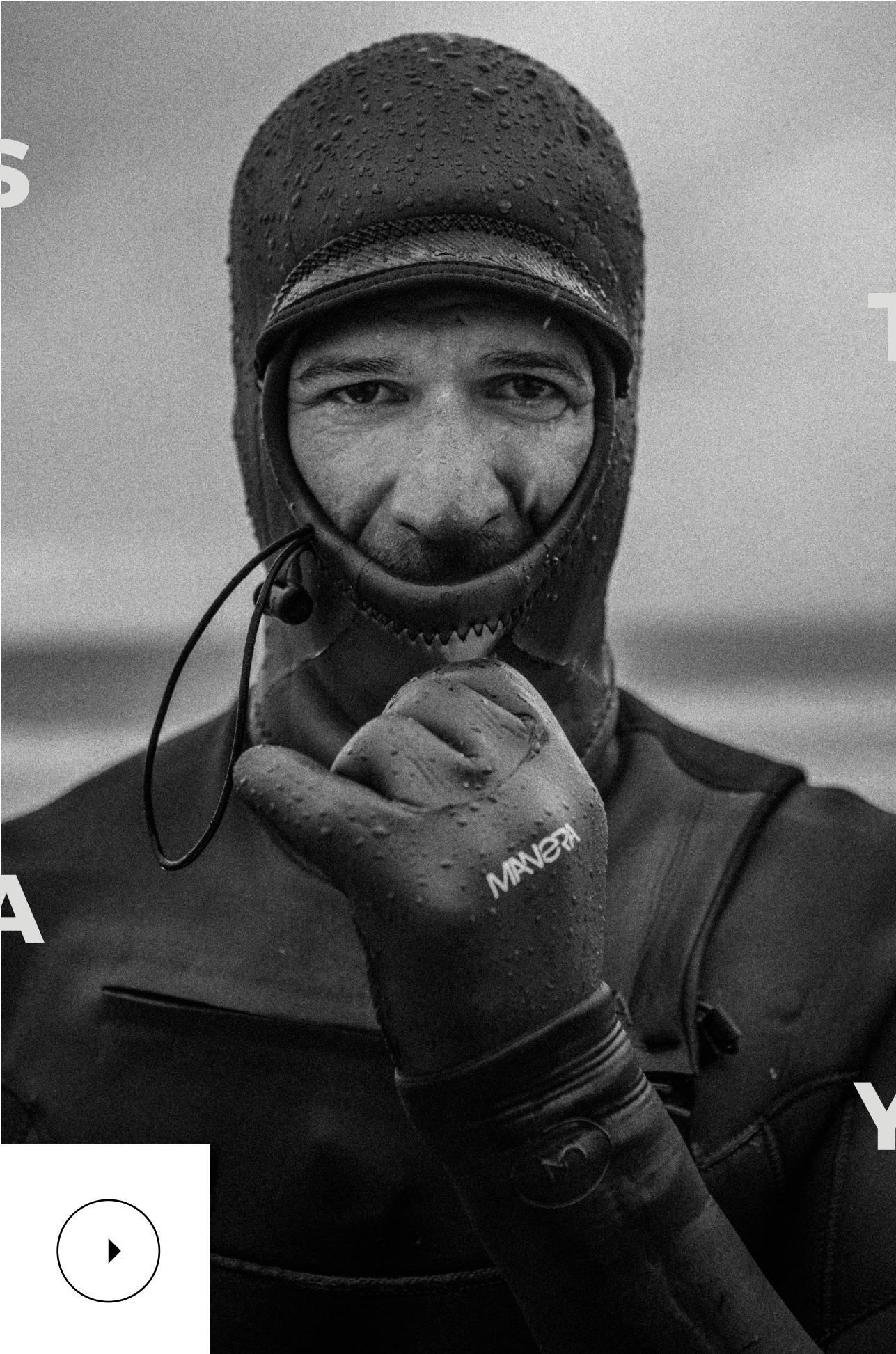

S

# STAY SALTY

---

A

We are a French family-business which develops Kiteboarding gear for demanding riders. We believe that the product is the heart of a company, and as a result most of our efforts are spent on the research, development and testing of the collection.

Our passion is about Kiteboarding as much as it is about creating and innovating, we enjoy both the hours spent at the office and the ones spent on the water.

*“ We have been into Kiteboarding since the beginning. “*

All over these years, we have seen how Kiteboarding evolved and how many people were hit by this passion. Today it's pure happiness to see all those guys & girls on the water with a big smile on their faces.

MANERA is meant to enable those people to make the most of their time in the ocean. We create products so nobody has to get out of the water because they are cold or uncomfortable.

**BECAUSE WE BELIEVE EVERY MOMENT OUT THERE SHOULD BE A GREAT ONE.**

**Julien SALLES**

T

Y



MEN

METEOR MAGMA



5.4.3

**Meteor Magma**  
Hooded - Front zip



5.4.3

**Meteor Magma**  
Front zip



4.3

**Meteor Magma**  
Front zip



5.4.3

**Meteor Magma**  
Back zip



4.3

**Meteor Magma**  
Back zip

METEOR X10D

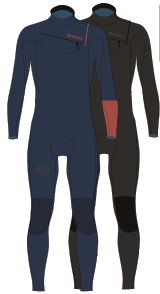

5.4.3

**Meteor X10D**  
Front zip

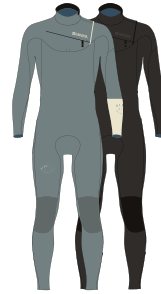

4.3

**Meteor X10D**  
Front zip

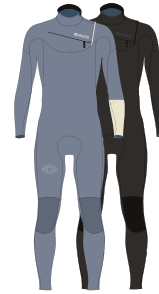

3.2

**Meteor X10D**  
Front zip



5.4.3

**Meteor X10D**  
Back zip



4.3

**Meteor X10D**  
Back zip



3.2

**Meteor X10D**  
Hybrid - Front zip



2.2

**Meteor X10D**  
Shorty - Front zip

WOMEN

METEOR MAGMA



5.4.3

**Meteor MAGMA**  
Front zip



5.4.3

**Meteor MAGMA**  
Back zip

NEOPRENE  
**OVER  
VIEW**

METEOR X10D



4.3

**Meteor X10D**  
Front zip



3.2

**Meteor X10D**  
Front zip



5.4.3

**Meteor X10D**  
Back zip



4.3

**Meteor X10D**  
Back zip



3.2

**Meteor X10D**  
Hybrid - Front zip



# MAGMA

## METEOR



### MATERIALS

#### 1 REFLEX SKIN

- Best stretch of the market
- Durable: Tear resistant, UV resistant

#### 2 AIRFOAM

- Made to be light, improving comfort & endurance
- Best flex & insulation on the market
- Quilted touch

#### 3 MAGMA FLEECE

- Plush loops work as insulators & heat generators
- Smooth, soft & comfy feeling against the skin
- Dries fast



### 3D DESIGNED

Our suits are directly designed on a model adopting a Kiteboarding specific position, for a much more natural feeling while riding.



# KEY FEATURES

WARMTH & COMFORT

## SD2 TAPE 2.0

- Triple glued / Blind stitched / Inside tape welded by an air heater machine
- Durable & Flex
- 100% waterproof



## SEALING PRINT

- Keep the water away
- Keep legs & arms panels in place



## BACK KNEE EMBOSS

- Helps the neoprene to bend more naturally
- Greater comfort during flexion

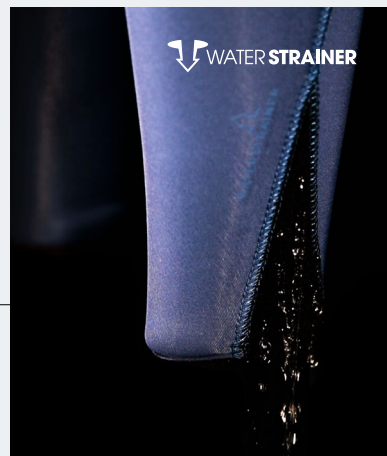

## WATER STRAINER

- Drains the water out of the leg
- Continue the session in the best possible conditions

PRODUCT VIDEO

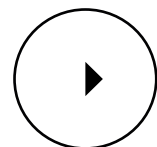



M E T E O R M A G M A



M E N  
**COLLE  
CTION**





**METEOR MAGMA**  
HOODED - FRONT ZIP

5.4.3

**DETAILS**

**REF.** 22201-0101  
**SIZING.** XS-S-M-ML-L-XL  
**COLORS.** BLACK

**FLEXIBILITY** 80%  
**WARMTH** 100%  
**COMFORT** 90%



**METEOR MAGMA**  
FRONT ZIP

5.4.3

**DETAILS**

**REF.** 22201-0102  
**SIZING.** XS-S-M-ML-L-XL  
**COLORS.** SLATE BLACK

**FLEXIBILITY** 90%  
**WARMTH** 95%  
**COMFORT** 100%

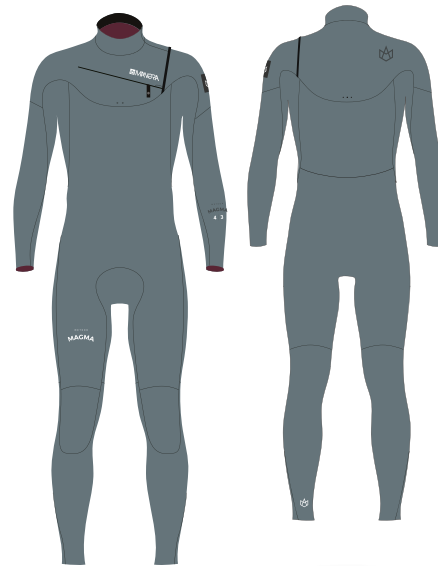

**METEOR MAGMA**  
FRONT ZIP

4.3

**DETAILS**

**REF.** 22201-0103  
**SIZING.** XS-S-M-ML-L-XL  
**COLORS.** STEEL BLUE

**FLEXIBILITY** 95%  
**WARMTH** 90%  
**COMFORT** 100%

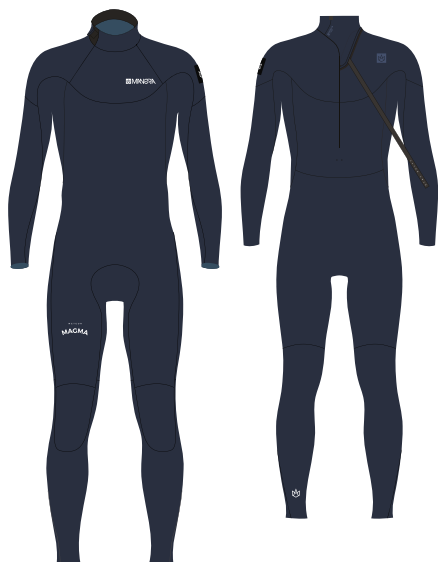

**METEOR MAGMA**  
BACK ZIP

5.4.3

**DETAILS**

<b>REF.</b>	<b>22201-0402</b>
<b>SIZING.</b>	XS-S-M-L-XL
<b>COLORS.</b>	SAILOR BLUE

FLEXIBILITY	<b>90%</b>
WARMTH	<b>95%</b>
COMFORT	<b>100%</b>



**METEOR MAGMA**  
BACK ZIP

4.3

**DETAILS**

<b>REF.</b>	<b>22201-0403</b>
<b>SIZING.</b>	XS-S-ML-XL
<b>COLORS.</b>	SAILOR BLUE

FLEXIBILITY	<b>95%</b>
WARMTH	<b>90%</b>
COMFORT	<b>100%</b>

# KEY FEATURES

## BACK ZIP

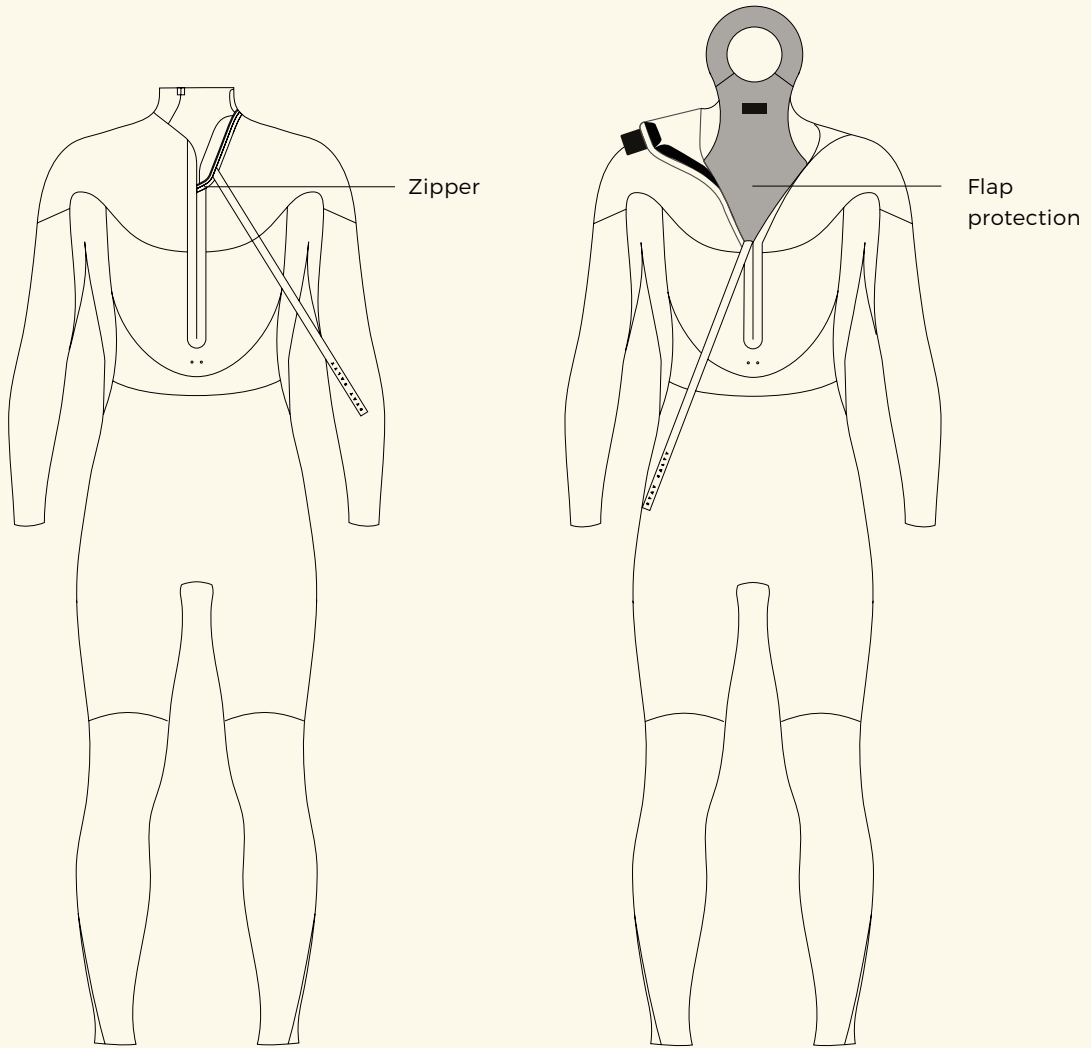

OUTSIDE

INSIDE



M E T E O R M A G M A

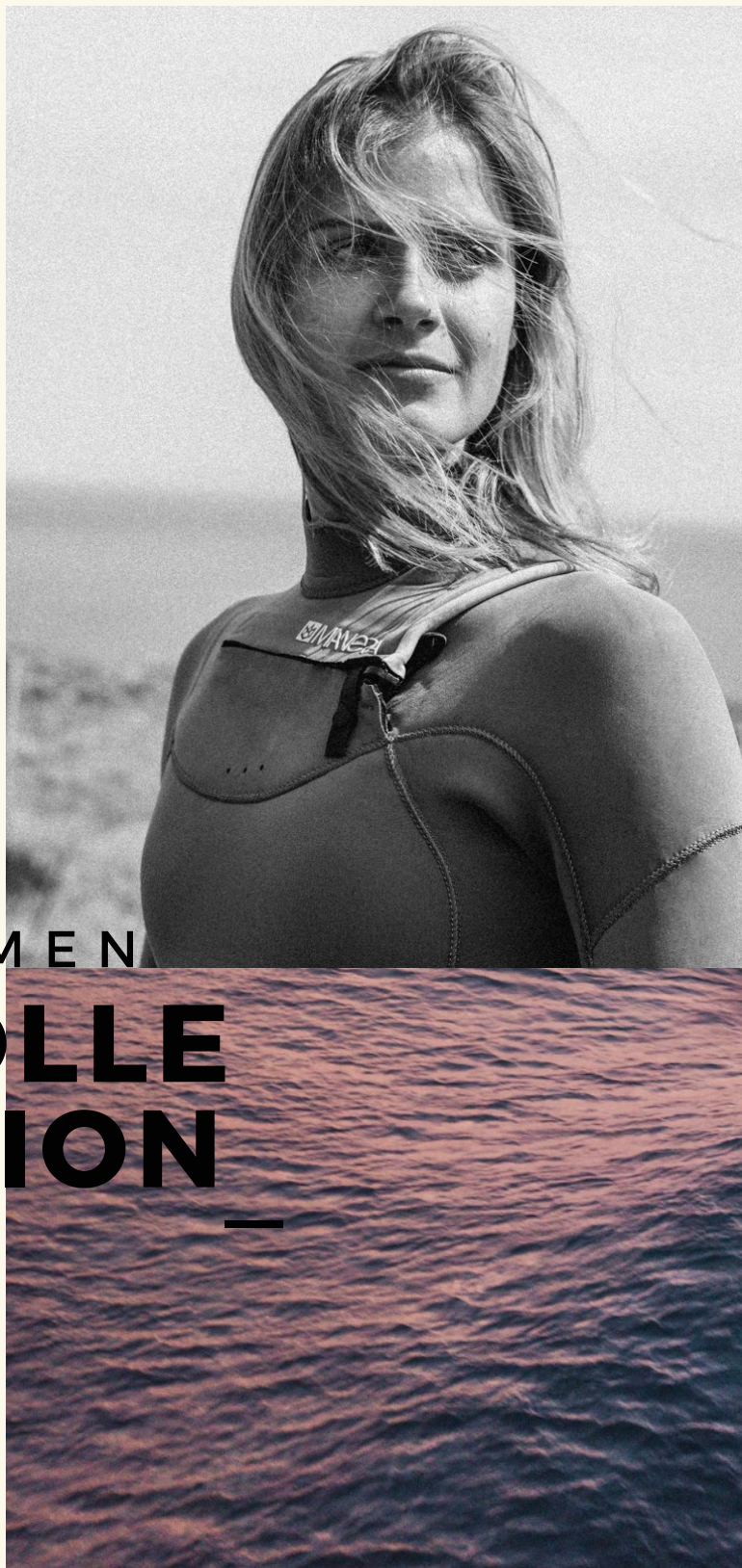

W O M E N  
**COLLE  
CTION**

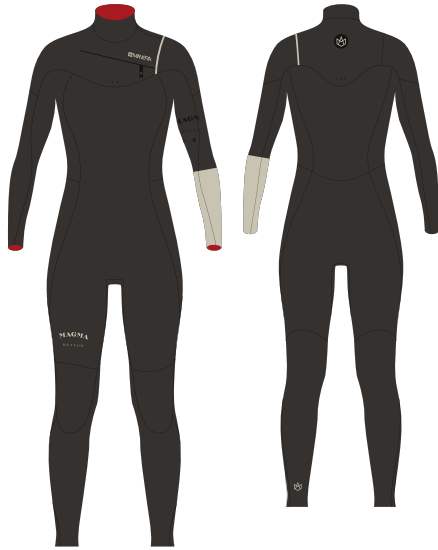

METEOR **MAGMA**  
FRONTZIP

5.4.3

**DETAILS**

**REF.** 22201-1002  
**SIZING.** XS-S-M-L  
**COLORS.** BLACK - CHAMPAGNE

**FLEXIBILITY** 90%  
**WARMTH** 95%  
**COMFORT** 100%

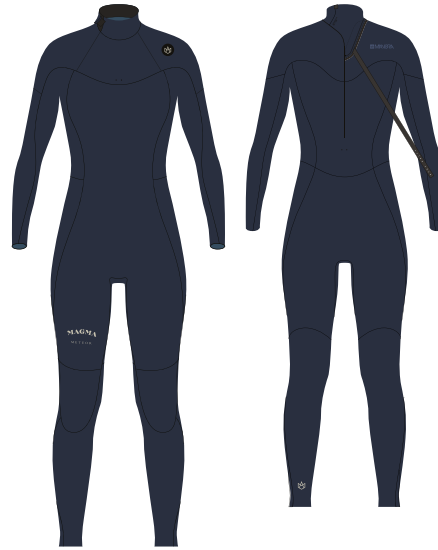

METEOR **MAGMA**  
BACKZIP

5.4.3

**DETAILS**

**REF.** 22201-4002  
**SIZING.** XS-S-M-L  
**COLORS.** SAILOR - CHAMPAGNE

**FLEXIBILITY** 90%  
**WARMTH** 95%  
**COMFORT** 100%



# X10D

M E T E O R



## MATERIALS

### 1 REFLEX SKIN

- Best stretch of the market
- Durable: Tear resistant, UV resistant

### 2 AIRFOAM

- Made to be light, improving comfort & endurance
- Best flex & insulation on the market
- Quilted touch

### 3 X10D JERSEY

- Light & stretch
- Good feeling on the skin



### 3D DESI- GNED

Our suits are directly designed on a model adopting a Kiteboarding specific position, for a much more natural feeling while riding.



# KEY FEATURES

STRETCH & LIGHT

## SD2 TAPE 2.0

- Triple glued / Blind stitched / Inside tape welded by an air heater machine
- Durable & Flex
- 100% waterproof



## WATER STRAINER

- Drains the water out of the leg
- Continue the session in the best possible conditions



## SEALING PRINT

- Keep the water away
- Keep legs panels in place



PRODUCT VIDEO

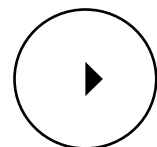



M E T E O R X 1 0 D



M E N  
**COLLE  
CTION**





## METEOR X10D

5.4.3

FRONTZIP

### DETAILS

REF. **22201-0202**

SIZING. XS-S-M-ML-L-XL

COLORS. INK BLUE - RUST RED  
/ BLACK

FLEXIBILITY **95%**

WARMTH **85%**

COMFORT **100%**



## METEOR X10D

4.3

FRONTZIP

### DETAILS

REF. **22201-0203**

SIZING. XS-S-M-ML-L-XL

COLORS. PEWTER - SILKY WHITE  
/ BLACK

FLEXIBILITY **100%**

WARMTH **80%**

COMFORT **100%**



## METEOR X10D

3.2

FRONTZIP

### DETAILS

REF. **22201-0204**

SIZING. XS-S-M-ML-L-XL

COLORS. STEEL BLUE - SILKY WHITE  
/ BLACK

FLEXIBILITY **100%**

WARMTH **75%**

COMFORT **100%**

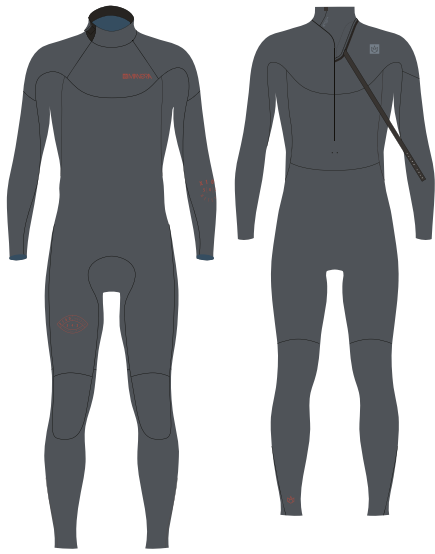

## METEOR X10D

BACK ZIP

5.4.3

### DETAILS

**REF.** 22201-0502  
**SIZING.** XS-S-M-ML-L-XL  
**COLORS.** SLATE BLACK - RUST RED

**FLEXIBILITY** 95%  
**WARMTH** 85%  
**COMFORT** 100%



## METEOR X10D

BACK ZIP

4.3

### DETAILS

**REF.** 22201-0503  
**SIZING.** XS-S-M-ML-L-XL  
**COLORS.** SLATE BLACK - CREAM

**FLEXIBILITY** 100%  
**WARMTH** 80%  
**COMFORT** 100%



## METEOR X10D

HYBRID - FRONTZIP

3.2

### DETAILS

<b>REF.</b>	<b>22201-0205</b>
<b>SIZING.</b>	XS-S-M-ML-L-XL
<b>COLORS.</b>	CASCADE - POWDER / SAILOR BLUE - RUST RED

FLEXIBILITY	<b>100%</b>
WARMTH	<b>65%</b>
COMFORT	<b>100%</b>



## METEOR X10D

SHORTY - FRONTZIP

2.2

### DETAILS

<b>REF.</b>	<b>22201-0206</b>
<b>SIZING.</b>	XS-S-M-ML-L-XL
<b>COLORS.</b>	SAILOR - CHAMPAGNE / PEWTER - SILKY WHITE

FLEXIBILITY	<b>100%</b>
WARMTH	<b>55%</b>
COMFORT	<b>100%</b>



M E T E O R X 1 0 D



W O M E N

**COLLE  
CTION**



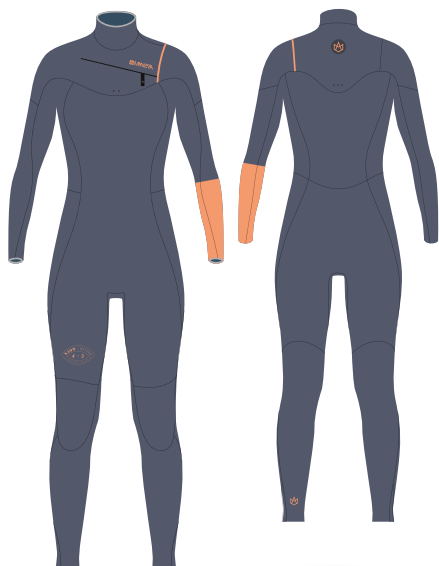

## METEOR X10D

FRONTZIP

4.3

### DETAILS

<b>REF.</b>	22201-2003
<b>SIZING.</b>	XS-S-M-L
<b>COLORS.</b>	CASCADE - CORAL

FLEXIBILITY	100%
WARMTH	80%
COMFORT	100%

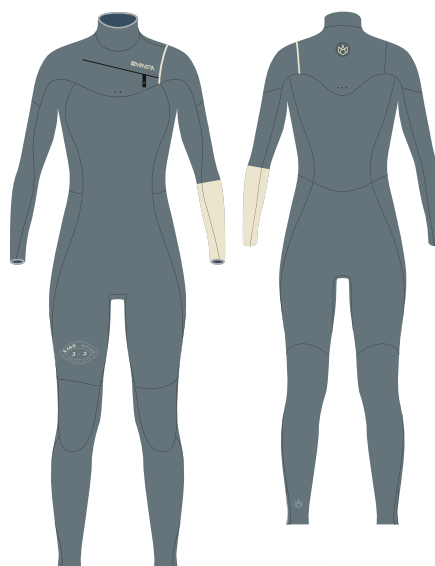

## METEOR X10D

FRONTZIP

3.2

### DETAILS

<b>REF.</b>	22201-2004
<b>SIZING.</b>	XS-S-M-L
<b>COLORS.</b>	STEEL BLUE - SILKY WHITE

FLEXIBILITY	100%
WARMTH	75%
COMFORT	100%

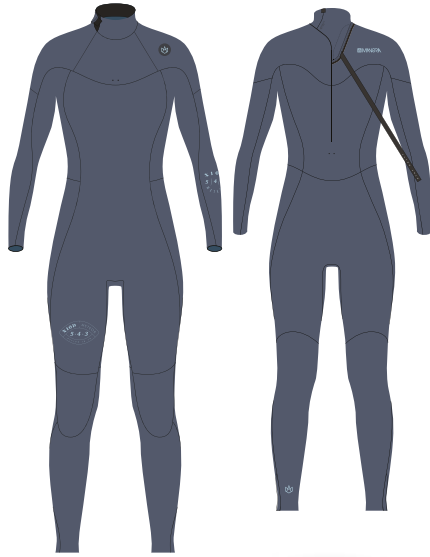

## METEOR X10D BACKZIP

5.4.3

### DETAILS

**REF.** 22201-5002  
**SIZING.** XS-S-M-L  
**COLORS.** CASCADE - ETHEREAL

**FLEXIBILITY** 100%  
**WARMTH** 85%  
**COMFORT** 100%

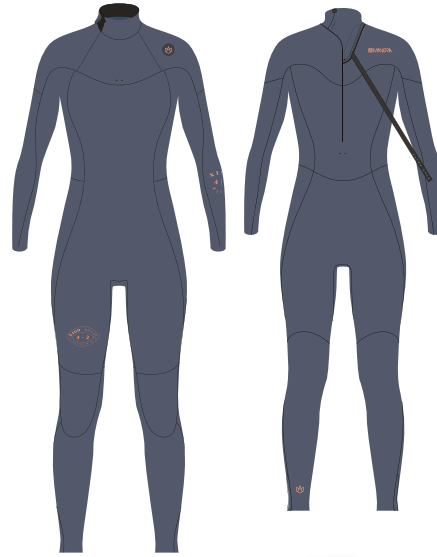

## METEOR X10D BACKZIP

4.3

### DETAILS

**REF.** 22201-5003  
**SIZING.** XS-S-M-L  
**COLORS.** CASCADE - CORAL

**FLEXIBILITY** 100%  
**WARMTH** 80%  
**COMFORT** 100%





## METEOR **X10D**

HYBRID - FRONTZIP

3.2

### DETAILS

**REF.** 22201-2005

**SIZING.** XS-S-M-L

**COLORS.** CASCADE - PEWTER - CORAL  
/ PEWTER - GLICER BLUE

**FLEXIBILITY** 100%

**WARMTH** 65%

**COMFORT** 100%





# THICKNESS — REPARTITION

MEN

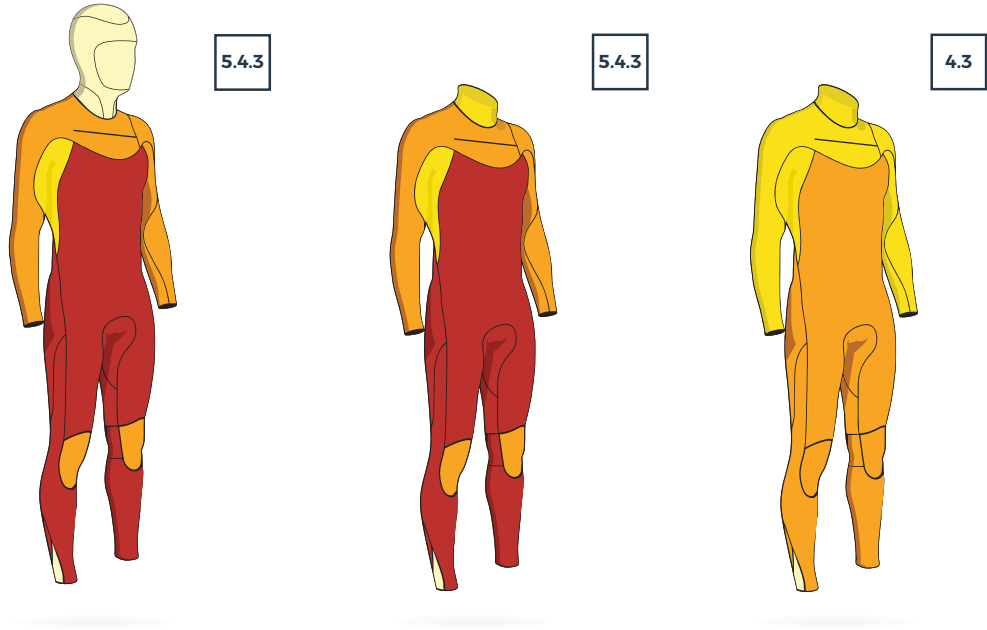

5 <sup>MM</sup>		50,7%	54,8%	57,7%
4 <sup>MM</sup>		33,2%	35,9%	42,3%
3 <sup>MM</sup>		7,4%	9,3%	
2 <sup>MM</sup>		8,8%		



4 <sup>MM</sup>		2,9%		
3 <sup>MM</sup>		56,1%	50,1%	1,7%
2 <sup>MM</sup>		40,9%	49,9%	98,2%

NEOPRNEE

WOMEN

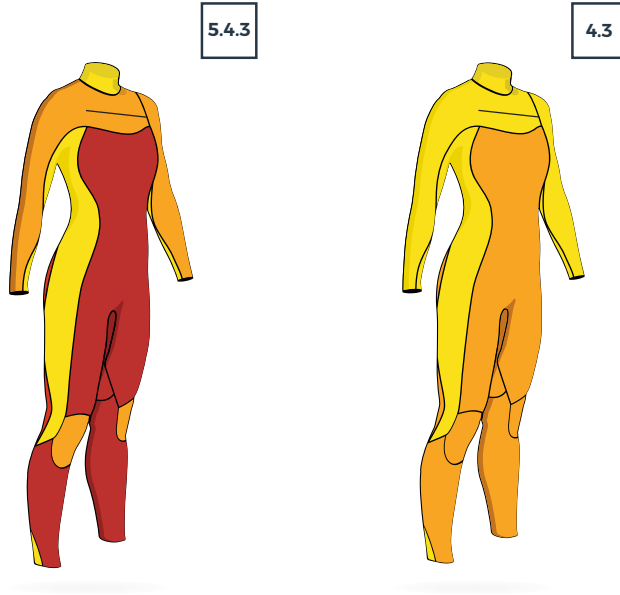

50,3%  
26,5%  
23,2%

52,9%  
47,1%

5<sup>MM</sup>  
4<sup>MM</sup>  
3<sup>MM</sup>

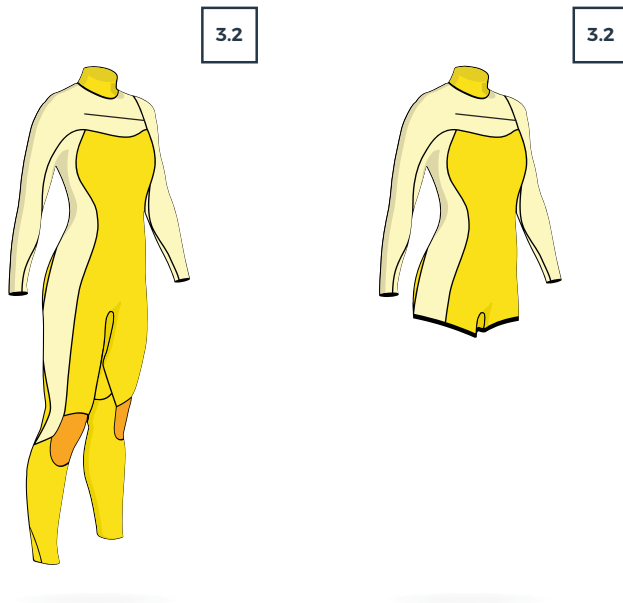

2,6%  
51,6%  
45,7%

37,2%  
62,8%

4<sup>MM</sup>  
3<sup>MM</sup>  
2<sup>MM</sup>



**ECLIPSE HARNESS**



Eclipse **Black**



Eclipse **Steel blue**

**STIFF  
NESS  
90%**



Eclipse **Chili**

---

**ACCESSORIES HARNESS**



**Sliding hook**



**Ropes Sliding hook**



**Kite knife**

EXO HARNESS

STIFFNESS  
60%



Exo **Black**



Exo **Tandori**



Exo **Aurora**

HARNESS  
**OVERVIEW**

STIFFNESS  
30%



Union **Sailor blue**



Union **Bordeaux**



Union **Jerry yellow**

UNION HARNESS



# ECLIPSE

## HARNESSES

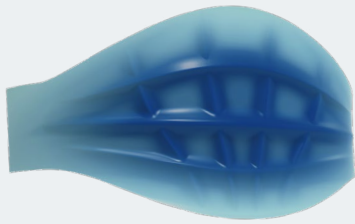

### ADAPTIVE SHELL

- The Adaptive Shell stiffness shades from hard in the center area to softer on the edges
- The stiff center-belt prevents the harness from folding and compressing your body while preserving a good lumbar support
- The softer outline preserves intuitive mobility and adaptability
- It results in a shell that is forgiving where you need flex and stiff where you want support

### R&D HARN-ESS

Having worked on ergonomic designs for a while, our goal was to push our frame concept to more stiffness, allowing a better support of the back & a lower fit.

But something 100% hard was not an option: Our back needs some adaptability & human morphology is unique.

So here comes the ECLIPSE, a skilful balance between stiffness & flex that brings support where you need it and the freedom to move the way you want.



STIFFNESS	90%
LIGHTNESS	95%
DURABILITY	95%

# KEY FEATURES

## SUPPORT & ADAPTIBILITY

### GEL FOAM

- The gel foam disperses pressure evenly & efficiently to provide a "pillow comfort", much appreciated during long sessions
- It creates a different sense of feeling while riding as it moves along with your movements, therefore the contact with the harness is more intuitive & it prevents any rash or rubbing discomfort



### SPREADER BAR

- Length of our bars are well suited so they will pull along both sides of the harness
- Avoids any lateral contraction on the body

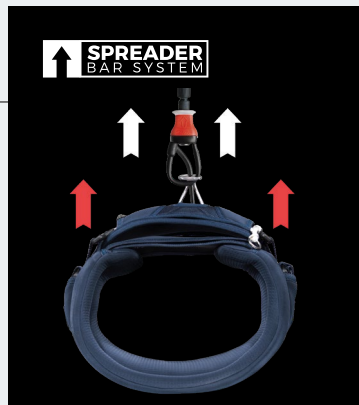

### DOWN HOLD SYSTEM

- The spreader bar has an asymmetrical attachment that distributes the forces downward.
- Secured in its original position, the hook does not ride back up



### TUCKFLAP

- Flaps are inserted into the harness, they are compressed and locked when straps are tighten
- Stiffen the connection between spreader bar & harness & prevent it from riding up

PRODUCT VIDEO

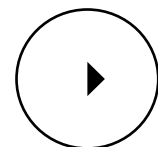



ECLIPSE HARNESS



COLLE  
CTION





BLACK



## ECLIPSE HARNESS

### DETAILS

REF.	22202-0100
SIZING.	XS-S-M-L-XL-XXL
COLORS.	BLACK / STEEL BLUE / CHILI

STIFFNESS	90%
LIGHTNESS	95%
DURABILITY	95%



STEEL BLUE



CHILI





# EXO

## HARNESSES



HIGH PRESSURE | LOW PRESSURE

### ENERGY DISPERSION FRAME

- Developed in close collaboration with a kinetic science lab to optimize load distribution.
- Avoids any unwanted muscular efforts to offset the bad traction
- Raised durability because the loads are not spread through soft parts

### SINGLE FOAM

- Thermoformed one-piece foam backing
- Much lighter than multiple foam layups used in some harnesses
- More durable as there are less parts to be glued or stitched together



### BALLISTIC NYLON

- Developed for the Royal Air Force during WWII
- Made of thick nylon threads
- Outstanding abrasion resistance, extreme durability



**STIFFNESS** 60%  
**LIGHTNESS** 90%  
**DURABILITY** 95%

# KEY FEATURES

ENERGY DISPERSION  
& COMFORT

## MANERA LEASH RELEASE

- Trigger the leashes easily with left or right hand
- Leash can be slideable or clamped between the two rings



## SPREADER BAR

- Length of our bars are well suited so they will pull along both sides of the harness
- Avoids any lateral contraction on the body

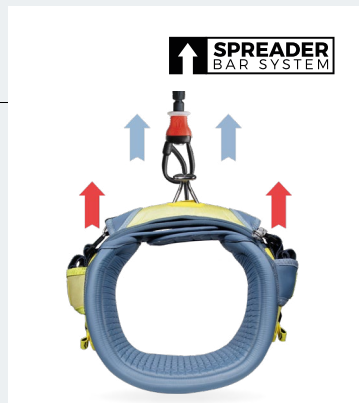

## DOWN HOLD SYSTEM

- The spreader bar has an asymmetrical attachment that distributes the forces downward
- Secured in its original position, the hook does not ride back up



## TUCKFLAP

- Flaps are inserted into the harness, they are compressed and locked when straps are tighten
- Stiffen the connection between spreader bar & harness & prevent it from riding up

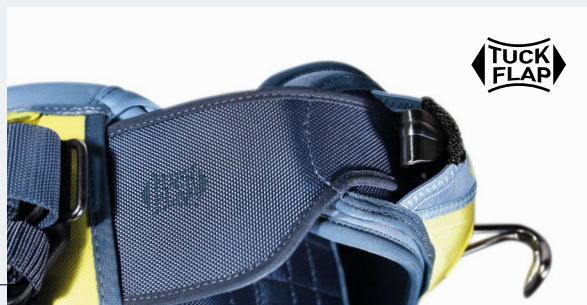



EXOHARNESS



COLLECTION



AURORA



## EXO HARNESS

### DETAILS

REF.	22202-0200
SIZING.	XS-S-M-L-XL-XXL
COLORS.	AURORA / TANDORI / BLACK

STIFFNESS	60%
LIGHTNESS	90%
DURABILITY	95%

# EXO

TANDORI



BLACK





# UNION

## H A R N E S S

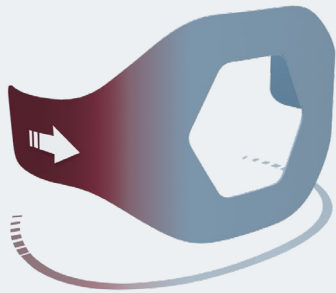

HIGH PRESSURE | LOW PRESSURE

### ENERGY DISPERSION PLATE

- Receives 100% of the kite power and spreads it smoothly around the back
- Avoids any unwanted muscular efforts to offset the bad traction
- Raised durability because the loads are not spread through soft parts

### SINGLE FOAM

- Thermoformed one-piece foam backing
- Much lighter than multiple foam layups used in some harnesses
- More durable as there are less parts to be glued or stitched together



STIFFNESS	30%
LIGHTNESS	100%
DURABILITY	90%

# KEY FEATURES

ENERGY DISPERSION  
& LIGHTNESS

## FEATHER WEIGHT

- Weighting in at just 1.1kg (Size M. No spreader bar)
- One of the lightest harness on the market
- Doesn't absorb water: Stays light while riding



## SPREADER BAR

- Length of our bars are well suited so they will pull along both sides of the harness
- Avoids any lateral contraction on the body



## DOWN HOLD SYSTEM

- The spreader bar has an asymmetrical attachment that distributes the forces downward
- Secured in its original position, the hook does not ride back up

## TUCKFLAP

- Flaps are inserted into the harness, they are compressed and locked when straps are tighten
- Stiffen the connection between spreader bar & harness & prevent it from riding up

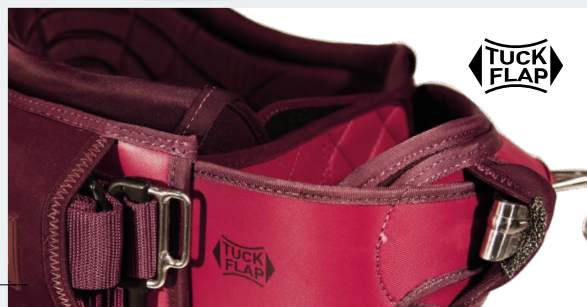

PRODUCT VIDEO

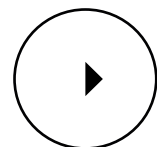



U N I O N H A R N E S S



COLLE  
CTION





SAILOR BLUE



## UNION HARNESS

### DETAILS

REF.	22202-0300
SIZING.	XS-S-M-L-XL-XXL
COLORS.	SAILOR BLUE / BORDEAUX / JERRY YELLOW

STIFFNESS	30%
LIGHTNESS	100%
DURABILITY	90%

U N I O N  
E N E R G Y D I S P E R S I O N P L A T E

BORDEAUX



JERRY YELLOW





HARNESSES  
ACCESSORIES



COLLE  
CTION

—



## SLIDING HOOK

### DETAILS

<b>REF.</b>	<b>22202-4001</b>
<b>SIZING.</b>	24CM - 28CM - 32CM (XS-S) - (M-L) - (XL-XXL)
<b>COLORS.</b>	BLACK



## ROPES SLIDING HOOK

### DETAILS

<b>REF.</b>	<b>22202-4002</b>
<b>SIZING.</b>	24CM - 28CM - 32CM (XS-S) - (M-L) - (XL-XXL)
<b>COLORS.</b>	BLACK



## KITE KNIFE

### DETAILS

<b>REF.</b>	<b>22202-5001</b>
<b>SIZING.</b>	UNIQUE
<b>COLORS.</b>	BLACK



BOARD BAGS



**747 Wheels**  
190x38x54cm



**747 Wheels**  
170x38x54cm

BOARD BAGS

**OVER  
VIEW**



**747 Light**  
190x34x54cm



**747 Light**  
170x34x54cm



**Compact 5'3"**  
165x56cm



**Surf 5'6" / 6'0"**  
170x55cm / 180x60cm



**Chubby Wheels**  
145x35x47cm



**Chubby Light**  
145x32x47cm



**Twin-tip**  
150x55cm

TRAVEL BAGS



**Biggie 160l**  
85x33x58cm



**Rugged bag 45l**  
65x30x23cm



**Rugged bag 20l**  
47x30x15cm

FOILBAGS



**Foil 5'3"**  
165x55cm



**Pocket 4'3"**  
135x55cm



**Kite foil box**  
310x1100mm



**Surf foil box**  
560x850mm

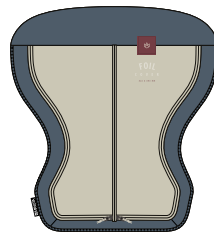

**Foil covers**  
680 / 840 / 1000mm



**Mast covers**  
650 / 750 / 850 / 1050mm

BOARDSOCKS



**Surf**  
5'6"



**Surf**  
5'10"



**Sup**  
7'3" - 7'11"



**Sup**  
7'11" / 8'6"



**Sup**  
8'6" / 9'6"



**Race**  
12'6" / 14"



**Foil**  
5'2"



B O A R D B A G S



COLLE  
CTION



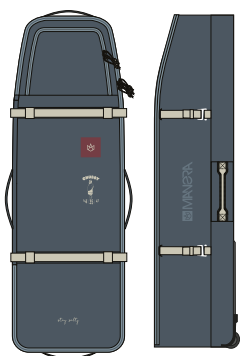

## CHUBBY WHEELS

145 X 35 X 47 CM

### DETAILS

<b>REF.</b>	<b>22203-0201</b>
<b>SIZING.</b>	145x35x47CM
<b>COLORS.</b>	SLATE - CREME

### FEATURES

- Premium 600D Polyester fabric
- Upper waterproof pocket
- High quality wheels
- Inside mesh pockets
- 4 reinforced handles
- Inside tightening straps
- 8mm protection foam
- Bottom reinforcement

CHUBBY

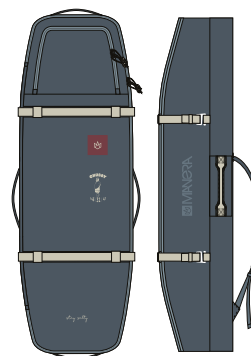

## CHUBBY LIGHT

145 X 32 X 47 CM

### DETAILS

<b>REF.</b>	<b>22203-0202</b>
<b>SIZING.</b>	145x32x47CM
<b>COLORS.</b>	SLATE - CREME

### FEATURES

- Premium 600D Polyester fabric
- Upper waterproof pocket
- Quick removable backpack straps
- Inside mesh pockets
- 4 reinforced handles
- Inside tightening straps
- 3mm protection foam

## BACK FEATURES

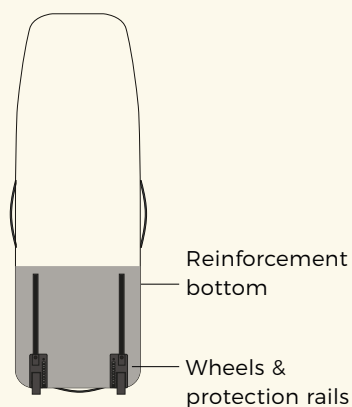

WHEELS

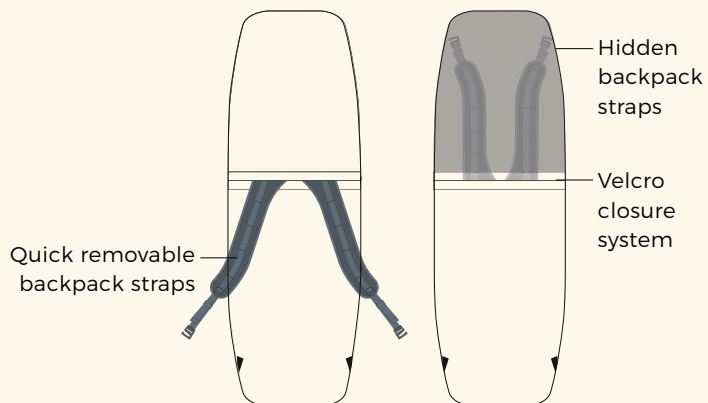

LIGHT

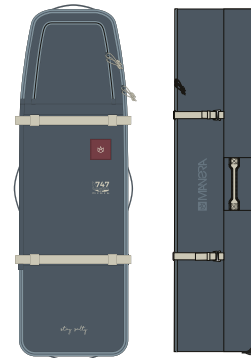
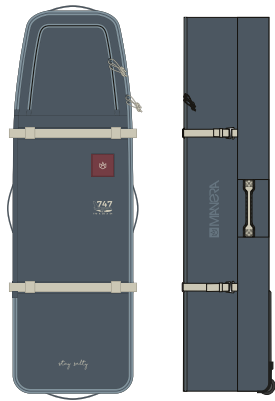

## 747 WHEELS

190 X 38 X 54 CM

### DETAILS

<b>REF.</b>	<b>22203-0203</b>
<b>SIZING.</b>	190x38x54CM
<b>COLORS.</b>	SLATE - CREME

### FEATURES

- Premium 600D Polyester fabric
- Upper waterproof pocket
- High quality wheels
- Inside mesh pockets
- 4 reinforced handles
- Inside tightening straps
- 8mm protection foam
- Bottom reinforcement

## 747 WHEELS

170 X 38 X 54 CM

### DETAILS

<b>REF.</b>	<b>22203-0203</b>
<b>SIZING.</b>	170x38x54CM
<b>COLORS.</b>	SLATE - CREME

### FEATURES

- Premium 600D Polyester fabric
- Upper waterproof pocket
- High quality wheels
- Inside mesh pockets
- 4 reinforced handles
- Inside tightening straps
- 8mm protection foam
- Bottom reinforcement

## B A C K F E A T U R E S

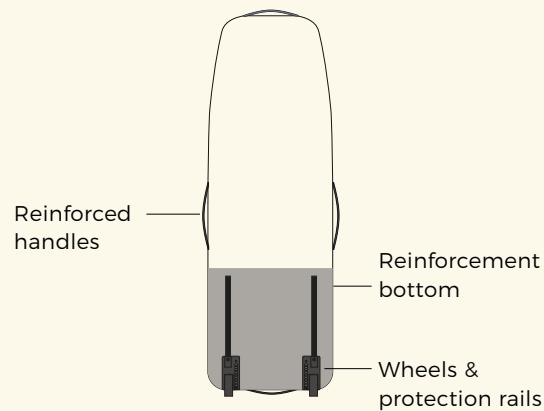

WHEELS 190/170

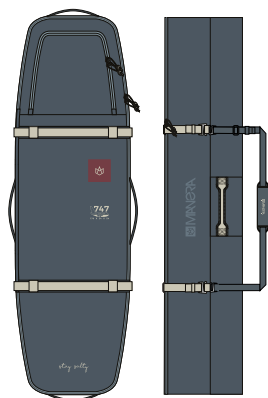

**747 LIGHT**

190 X 34 X 54 CM

**DETAILS**

<b>REF.</b>	<b>22203-0204</b>
<b>SIZING.</b>	190x34x54CM
<b>COLORS.</b>	SLATE - CREME

**FEATURES**

- Premium 600D Polyester fabric
- Upper waterproof pocket
- Inside mesh pockets
- 4 reinforced handles
- Inside tightening straps
- 3mm protection foam

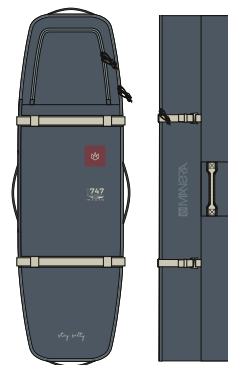
**747 LIGHT**

170 X 34 X 54 CM

**DETAILS**

<b>REF.</b>	<b>22203-0204</b>
<b>SIZING.</b>	170x34x54CM
<b>COLORS.</b>	SLATE - CREME

**FEATURES**

- Premium 600D Polyester fabric
- Upper waterproof pocket
- Quick removable backpack straps
- Inside mesh pockets
- 4 reinforced handles
- Inside tightening straps
- 3mm protection foam

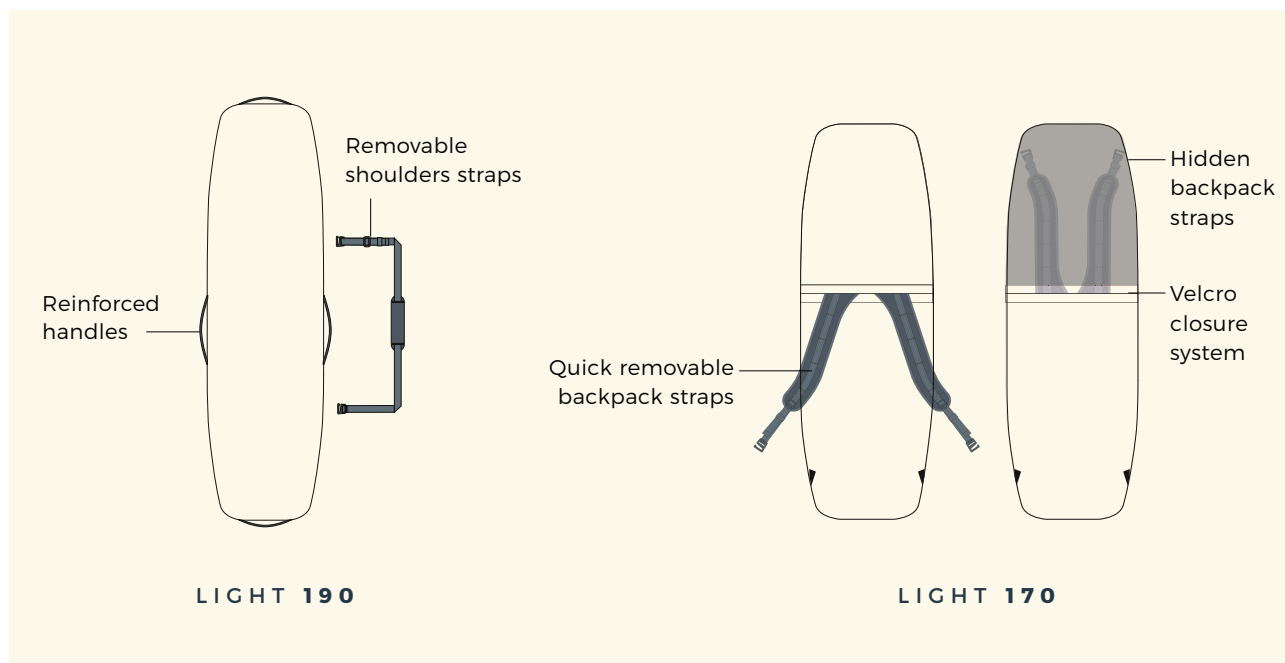
**B A C K F E A T U R E S**

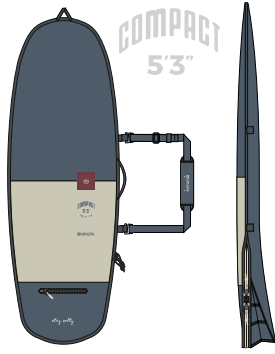

## COMPACT

5' 3"  
165 X 56 CM

### DETAILS

**REF.** 22203-0104  
**SIZING.** 5'3" - 165x56CM  
**COLORS.** SLATE - CREME

### FEATURES

- Premium 600D Polyester fabric
- Expandable fins volume
- Removable shoulder strap
- Zipper pocket
- One side handle



## SURF

5' 6" / 6' 0"  
170 X 55 CM / 180 X 60 CM

### DETAILS

**REF.** 22203-0105 / 22203-0106  
**SIZING.** 5'6" - 170x55cm / 6'0" - 180x60CM  
**COLORS.** SLATE - CREME

### FEATURES

- Premium 600D Polyester fabric
- Expandable fins volume
- Removable shoulder strap
- Zipper pocket
- One side handle



## BACK FEATURES

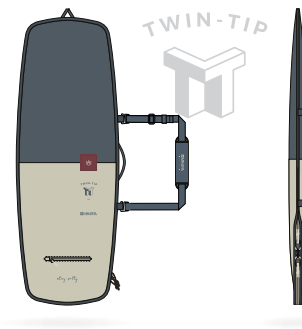
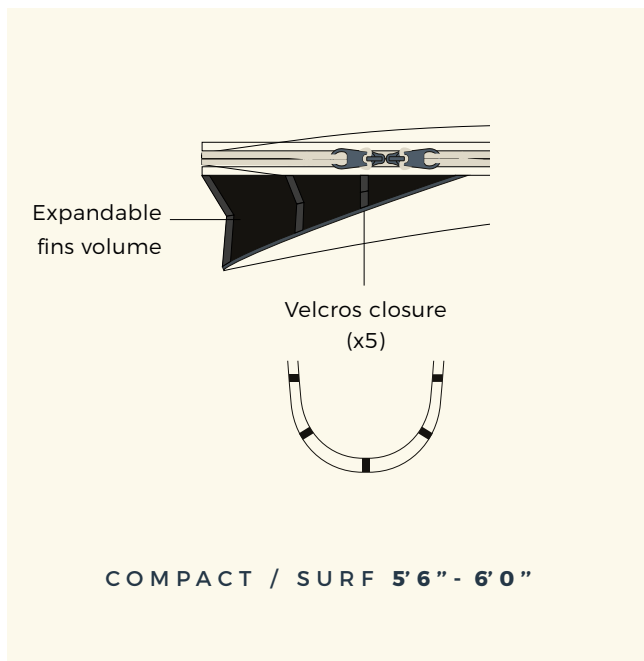

## TWIN-TIP

142 X 55 CM

### DETAILS

**REF.** 22203-0101  
**SIZING.** 150x55CM  
**COLORS.** SLATE - CREME

### FEATURES

- Premium 600D Polyester fabric
- Zipper pocket
- One side handle
- Removable shoulder strap



F O I L B A G S



**COLLE  
CTION** —



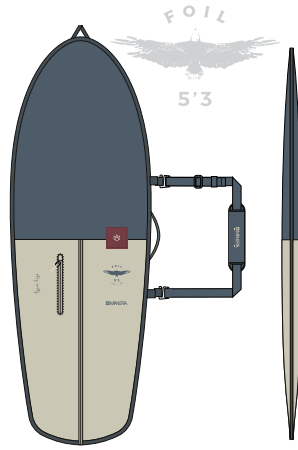

## FOIL

5'3"  
165 X 56 CM

### DETAILS

**REF.** 22203-0103  
**SIZING.** 5'3" - 165x56CM  
**COLORS.** SLATE - CREME

### FEATURES

- Premium 600D Polyester fabric
- Foil-specific entry
- No zipper : Closes with velcro
- Removable shoulder strap
- Zipper pocket
- One side handle



## POCKET

4'3"  
135 X 55 CM

### DETAILS

**REF.** 22203-0102  
**SIZING.** 4'3" - 135x55CM  
**COLORS.** SLATE - CREME

### FEATURES

- Premium 600D Polyester fabric
- Foil-specific entry
- No zipper : Closes with velcro
- Removable shoulder strap
- Zipper pocket
- One side handle



## BACK FEATURES

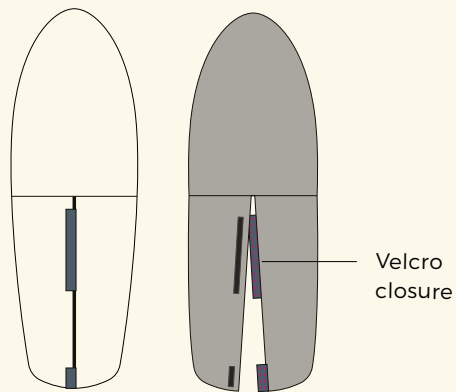

FOIL 5'3"

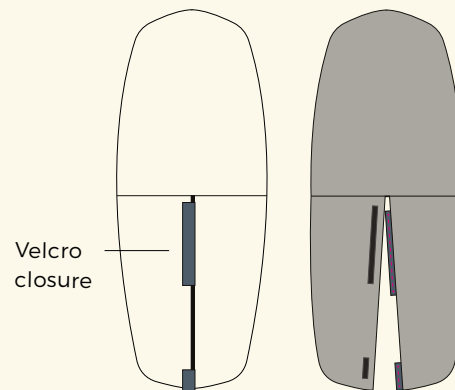

POCKET 4'3"

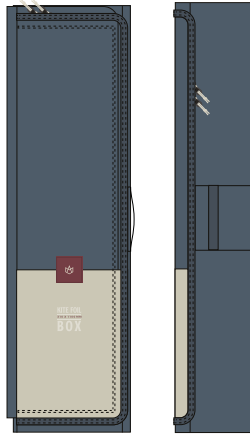

## KITE FOIL BOX

310 X 1100 CM

### DETAILS

<b>REF.</b>	<b>22203-0303</b>
<b>SIZING.</b>	310x1100CM
<b>COLORS.</b>	SLATE - CREME

### FEATURES

- Premium 600D Polyester fabric
- High density foam protection
- 3 compartments
- Elastic straps attach
- Inside pocket for accessories
- One side handle

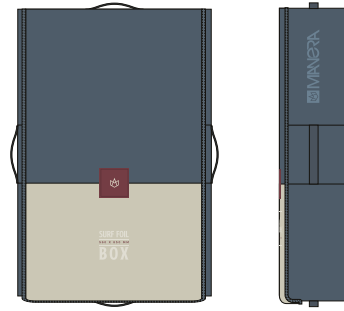

## SURF FOIL BOX

560 X 850 CM

### DETAILS

<b>REF.</b>	<b>22203-0304</b>
<b>SIZING.</b>	560x850CM
<b>COLORS.</b>	SLATE - CREME

### FEATURES

- Premium 600D Polyester fabric
- High density foam protection
- Elastic straps attach
- Inside pocket for accessories
- 4 side handles



## INSIDE FEATURES

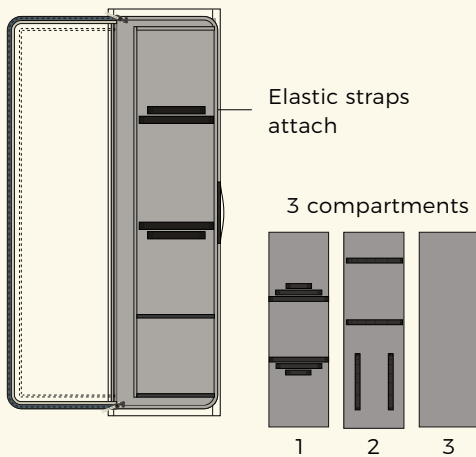

KITE FOIL BOX

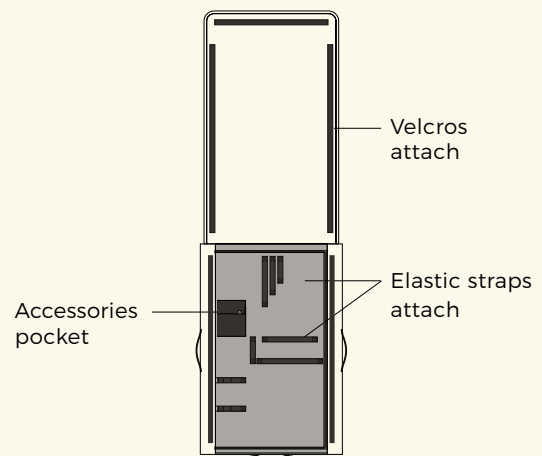

SURF FOIL BOX

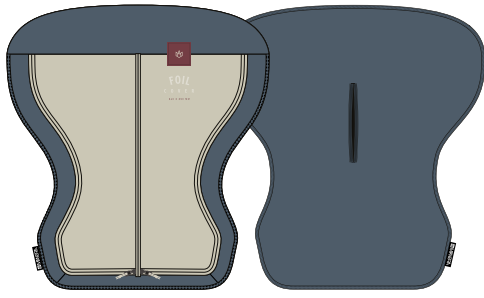

## FOIL COVERS

680 / 840 / 1000 X 890MM

### DETAILS

**REF.** 22203-0302  
**SIZING.** 5680 / 840 / 1000 x890CM  
**COLORS.** SLATE - CREME

### FEATURES

- Premium 600D Polyester fabric
- High density foam protection
- Inside reinforcements
- Slot to access mast screws

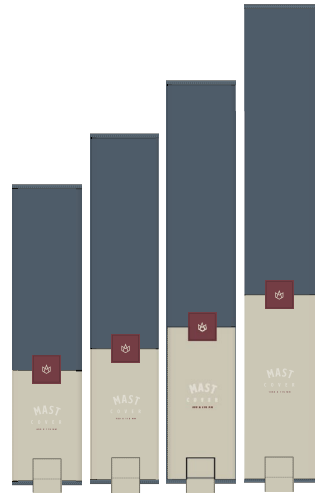

## MAST COVERS

650 / 750 / 850 / 1050MM

### DETAILS

**REF.** 22203-0301  
**SIZING.** 650 / 750 / 850 / 1050CM  
**COLORS.** SLATE - CREME

### FEATURES

- Premium 600D Polyester fabric
- High density foam protection
- Velcro closure



## BACK FEATURES

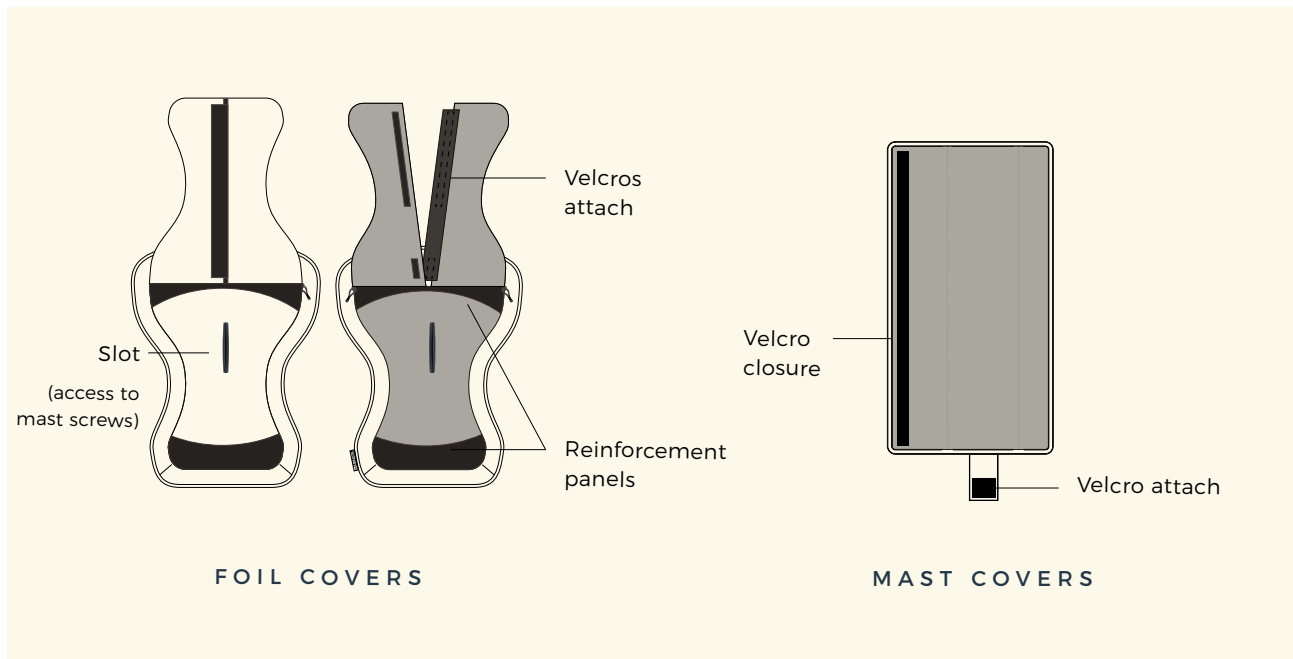

T R A V E L B A G S



COLLE  
CTION





## RUGGED DAY BAG

20 L  
47 X 30 X 15 CM

### DETAILS

REF. **22203-0402**  
SIZING. 20L - 47x30x15CM  
COLORS. ANTHRACITE - SUEDE

### FEATURES

- Premium coated Polyester material
- Mesh shoulder straps
- 2 outside pockets
- 1 inside mesh pocket
- Computer pocket



## RUGGED DUFFLE BAG

45 L  
65 X 30 X 23 CM

### DETAILS

REF. **22203-0401**  
SIZING. 45L - 65x30x23CM  
COLORS. ANTHRACITE - SUEDE

### FEATURES

- Premium coated Polyester material
- Removable backpack straps
- 1 side expandable pocket
- 1 outside pocket
- 1 inside mesh pocket

## INSIDE FEATURES

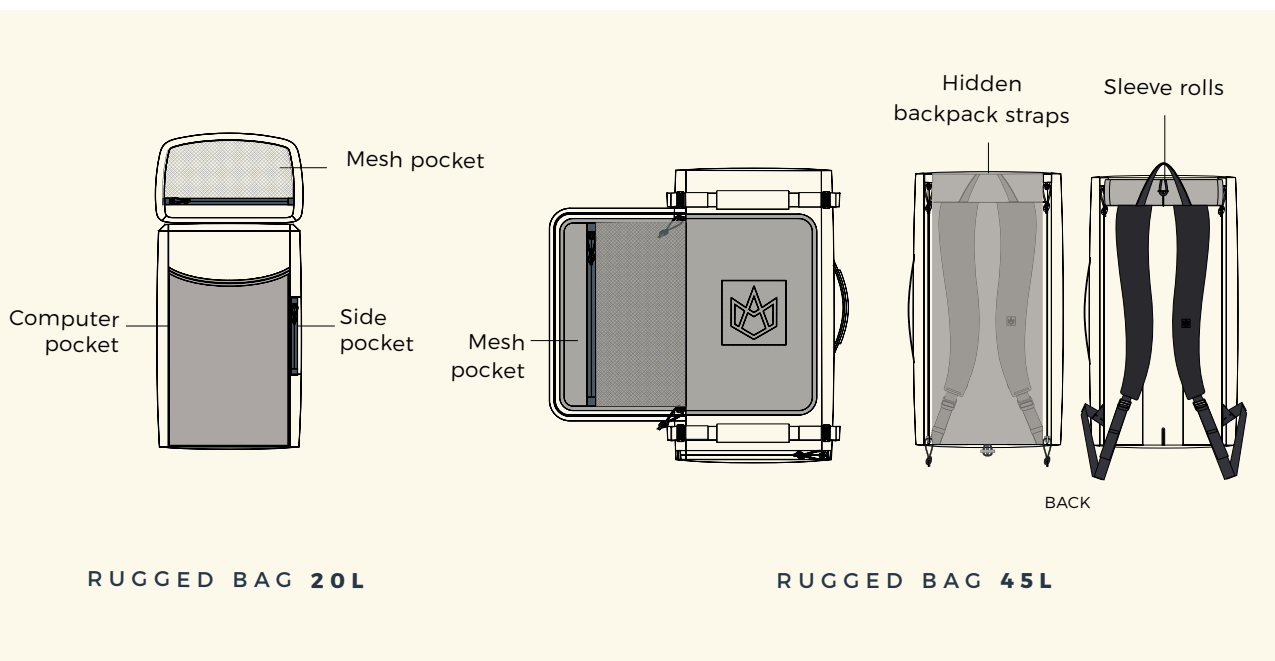

RUGGED BAG 20L

RUGGED BAG 45L





## BIGGIE

160 L  
85 X 33 X 58 CM

### DETAILS

**REF.** 22203-0205  
**SIZING.** 160L - 85x33x58CM  
**COLORS.** SLATE - CREME

### FEATURES

- Premium 600D Polyester fabric
- Straps reinforcements + aluminium tension hooks
- 6 reinforced handles
- 1 mesh pocket
- 1 accessories pocket

## I N S I D E F E A T U R E S

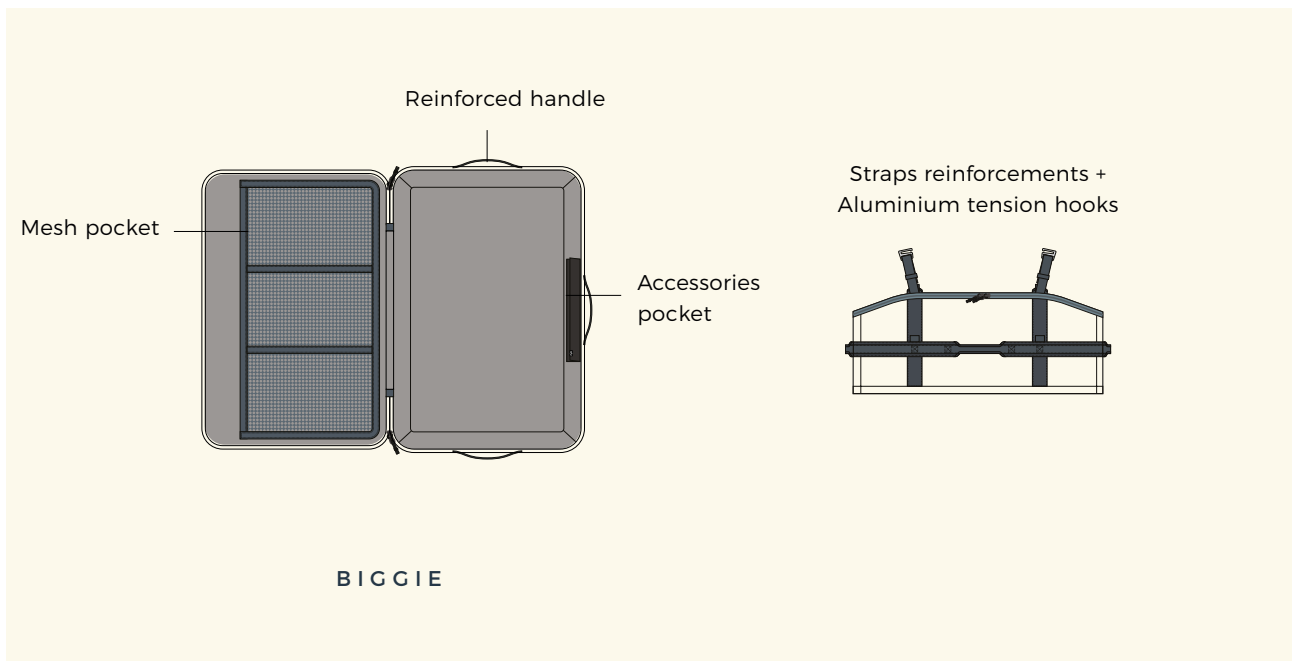



**B O A R D S O C K S**



**COLLE  
CTION**





**SURF 5'6"**

REF. 22203-0502



**SURF 5'10"**

REF. 22203-0502

## BOARDSOCKS

### DETAILS

#### FITS.

ONE COMPLETE BOARD (PADS, FINS)

#### SIZING.

ONE SOCK CAN FIT MANY SIZES, SEE THE RANGE SHOWN AGAINST FOR MORE INFORMATION



**SUP 7'3" - 7'11"**

REF. 22203-0503



**SUP 7'11" - 8'6"**

REF. 22203-0503



**SUP 8'6" - 9'6"**

REF. 22203-0503



**FOIL 5'2"**

REF. 22203-050

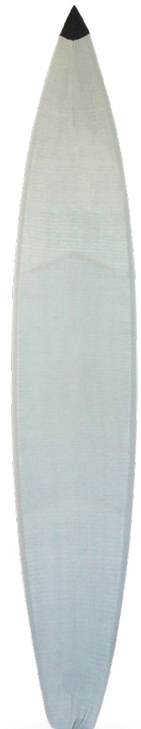

**RACE 12'6"- 14'**

REF. 22203-0504



TECHNICAL ACCESSORIES



**Blizzard**  
Kiteboarding jacket



**Boom vest**  
Impact vest



**X10D vest**  
Impact vest

NEOPRENE ACCESSORIES



2.5  
mm

**Magma hood**



2.0  
mm

**X10D hood**



2.5  
mm

**Magma glove**



2.0  
mm

**X10D glove**

# ACCESSORIES OVERVIEW

ACCESSORIES



**Magic wax**  
Base coat / Ultra sticky



**Bamboo poncho**



**Car seat cover**



**Caps**



TECHNICAL  
ACCESSORIES



COLLE  
CTION





## BLIZZARD

### KITEBOARDING JACKET

#### DETAILS

<b>REF.</b>	<b>22205-0300</b>
<b>SIZING.</b>	S-M-L-XL
<b>COLORS.</b>	SAILOR BLUE

#### FEATURES

- 3 layers vest
- Light, waterproof & windproof
- Spreaderbar passes through the 2 side pockets
- Breathability to go SUPing, biking, or wear it in the street



HARNES INSERT  
VIEW

The Blizzard jacket creates a cocoon around the Kiter that allows a far better resistance to cold even with a standard wetsuit.

Whether you are on the water or debriefing the session on the beach, the Blizzard will keep you warm & comfy.

## FEATURES

### WIND STOPPER

The 3 laminated layers are working like a hedge to cut the wind and protect the body from cold gusts.

### WATER REPELLENT

The pores in our internal membrane are not big enough to let water drops pass through.



### BREATHABLE

Thanks to its micro-perforated internal membrane, the jacket evacuates moisture and prevents the body from being wet.



## BOOM VEST

IMPACT VEST

### DETAILS

<b>REF.</b>	<b>22205-0100</b>
<b>SIZING.</b>	S-M-L-XL
<b>COLORS.</b>	SLATE BLACK - ALLOY BLUE / BLACK

### FEATURES

- Shot gum foam
- Hyper stretch - X10D jersey
- Harness zone
- Anti-slip
- Zipper closure



## X10D VEST

IMPACT VEST

### DETAILS

<b>REF.</b>	<b>22205-0200</b>
<b>SIZING.</b>	S-M-L-XL
<b>COLORS.</b>	INK BLUE / BLACK

### FEATURES

- Shot gum foam
- Hyper stretch - X10D jersey
- Harness zone
- Anti-slip

## FEATURES

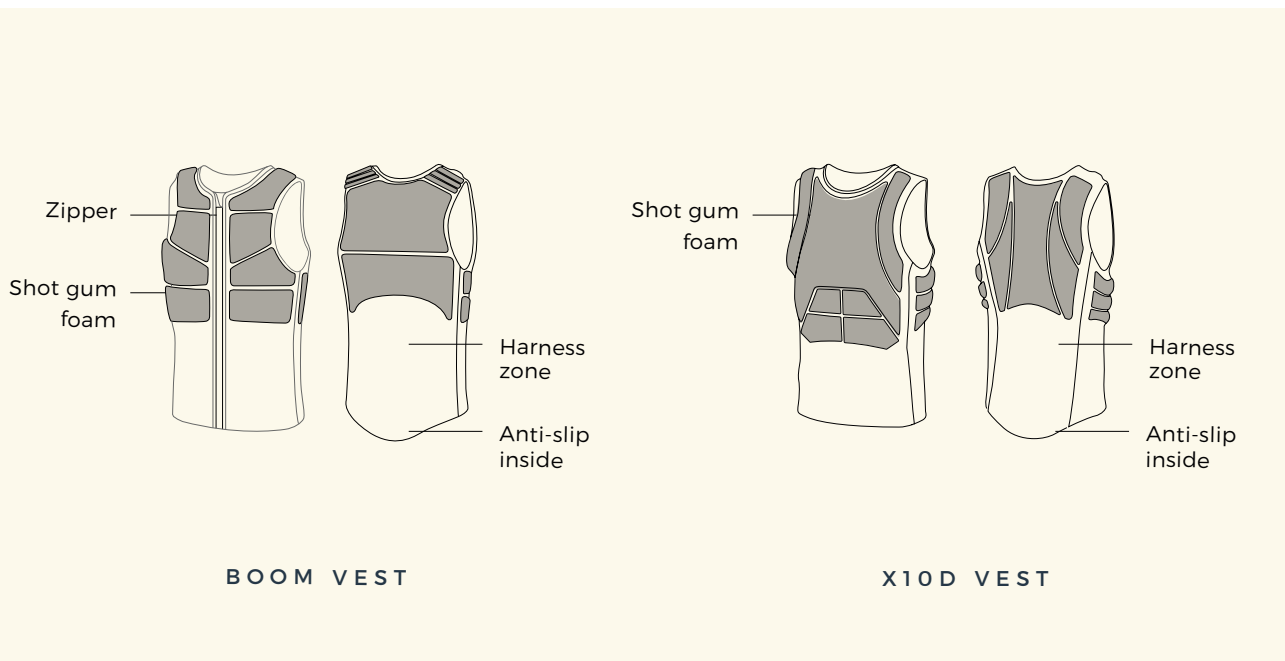

BOOM VEST

X10D VEST







NEOPRENE  
ACCESSORIES

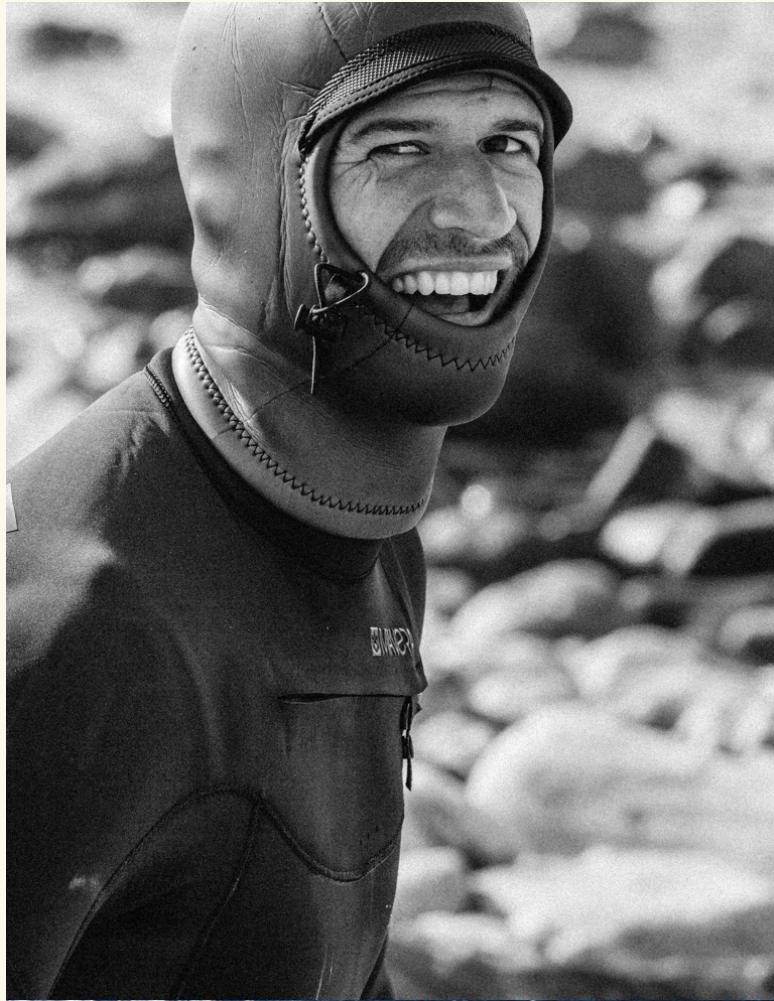

COLLE  
CTION





**MAGMA HOOD**  
COLD SESSION

2.5  
mm

**DETAILS**

**REF.** 22201-0807  
**SIZING.** S-M-L-XL  
**COLORS.** BLACK



**X10D HOOD**  
COLD SESSION

2.0  
mm

**DETAILS**

**REF.** 22201-0908  
**SIZING.** S-M-L-XL  
**COLORS.** BLACK



**MAGMA GLOVE**  
COLD SESSION

2.5  
mm

**DETAILS**

**REF.** 22201-0607  
**SIZING.** S-M-L-XL  
**COLORS.** BLACK



**X10D GLOVE**  
COLD SESSION

2.0  
mm

**DETAILS**

**REF.** 22201-0708  
**SIZING.** S-M-L-XL  
**COLORS.** BLACK



A C C E S S O R I E S



**COLLE  
CTION** —





## BAMBOO PONCHO

### DETAILS

<b>REF.</b>	<b>22206-0300</b>
<b>SIZING.</b>	ONE SIZE
<b>COLORS.</b>	DARK NAVY / GRIZZLY



## CAR SEAT COVER

### DETAILS

<b>REF.</b>	<b>22206-0400</b>
<b>SIZING.</b>	ONE SIZE
<b>COLORS.</b>	BLACK - WHITE



## MAGIC WAX

### DETAILS

<b>REF.</b>	<b>22206-0100</b>
-------------	-------------------

### FEATURES

- Extremely sticky
- Works on pads
- Doesn't melt in the sun
- 100% natural ingredients
- Non toxic



## CAPS

### DETAILS

---

<b>REF.</b>	<b>22206-0500</b>
<b>SIZING.</b>	ONE SIZE
<b>COLORS.</b>	RIPSTOP - BLACK / RIPSTOP - ALLOY BLUE / WOOL NOUGAT / WOOL BLACK / TRUCKER - WINETASTING / TRUCKER - SAILOR BLUE / DUCK GREEN / DESERT SUN

---







APPAREL



DARK NAVY BLUE

**Grindavik**  
22207-0300



GRIZZLY



HEATHER GREY

**Ponta preta**  
22207-0400



GRIZZLY



DARK NAVY BLUE



GREY

**Sweat hoodie**  
22207-0200



SLATE



SNOWFLAKES

**Women T-shirt**  
22207-1000



BLACK



BRICK

**Men T-shirt**  
22207-0100



SNOWFLAKES



APRICOT



SLATE



BLACK

WOMEN  
SIZES XS-S-M-L-XL  
COMPOSITION Basic

MEN  
SIZES S-M-L-XL-XXL  
COMPOSITION Basic



# APPAREL OVER VIEW



HEATHER GREY GRIZZLY BABY BLUE ANTHRACITE

**Dakhla**  
22207-0500



ANTHRACITE WHITE DARK NAVY BLUE

**Le morne LS**  
22207-0600



WHITE DARK NAVY BLUE ANTHRACITE

**Le morne**  
22207-0700



DARK NAVY BLUE WHITE HEATHER GREY

**Lavanono LS**  
22207-0800



HEATHER GREY DARK NAVY BLUE KHAKI BABY BLUE WHITE ANTHRACITE

**Lavanono**  
22207-0900

**F-ONE SAS**

ZAC de la Méditerranée  
170, Route de la Foire  
34470 PÉROLS - FRANCE

Tél. +33 (0) 4 67 99 51 16  
Fax. +33 (0) 4 67 99 61 93  
[WWW.MANERA.COM](http://WWW.MANERA.COM)

