

# Halo

MODE D'EMPLOI



 MANERA

# SPARE PARTS

HARNAIS HALO

## Composants.

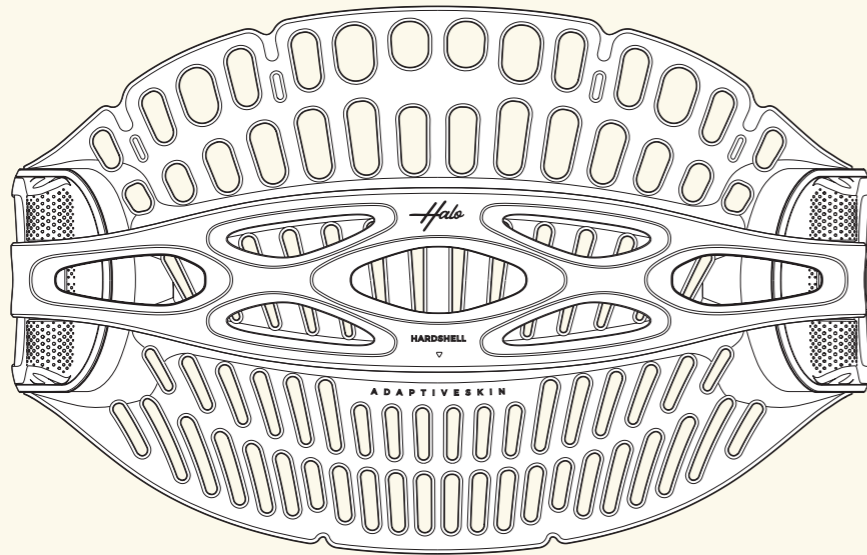

### UN PRODUIT EST AUSSI DURABLE QUE LE MOINS DURABLE DE SES COMPOSANTS.

Les différentes composantes d'un harnais sont souvent non remplaçables (sangles cousues, mousses collées...) et encore moins recyclables. Il arrive donc qu'une partie usée ou endommagée oblige à jeter le produit entier.

Dans une démarche de réduction de notre empreinte carbone et dans le but d'offrir un meilleur service à nos clients, tous les composants du HALO sont assemblés sans colle ni couture, ils sont donc tous facilement remplaçables.

- 1 SOFT SPARE PARTS
- 2 ARC BUCKLES
- 3 STRAP & PLASTIC BUCKLE
- 4 PIVOT INTER
- 5 PIVOT EXTER
- 6 7 M5 SCREW + M5 NUT FOR AXIS
- 8 ADAPTIVE SKIN
- 9 HARDSHELL
- 10 KITE KNIFE

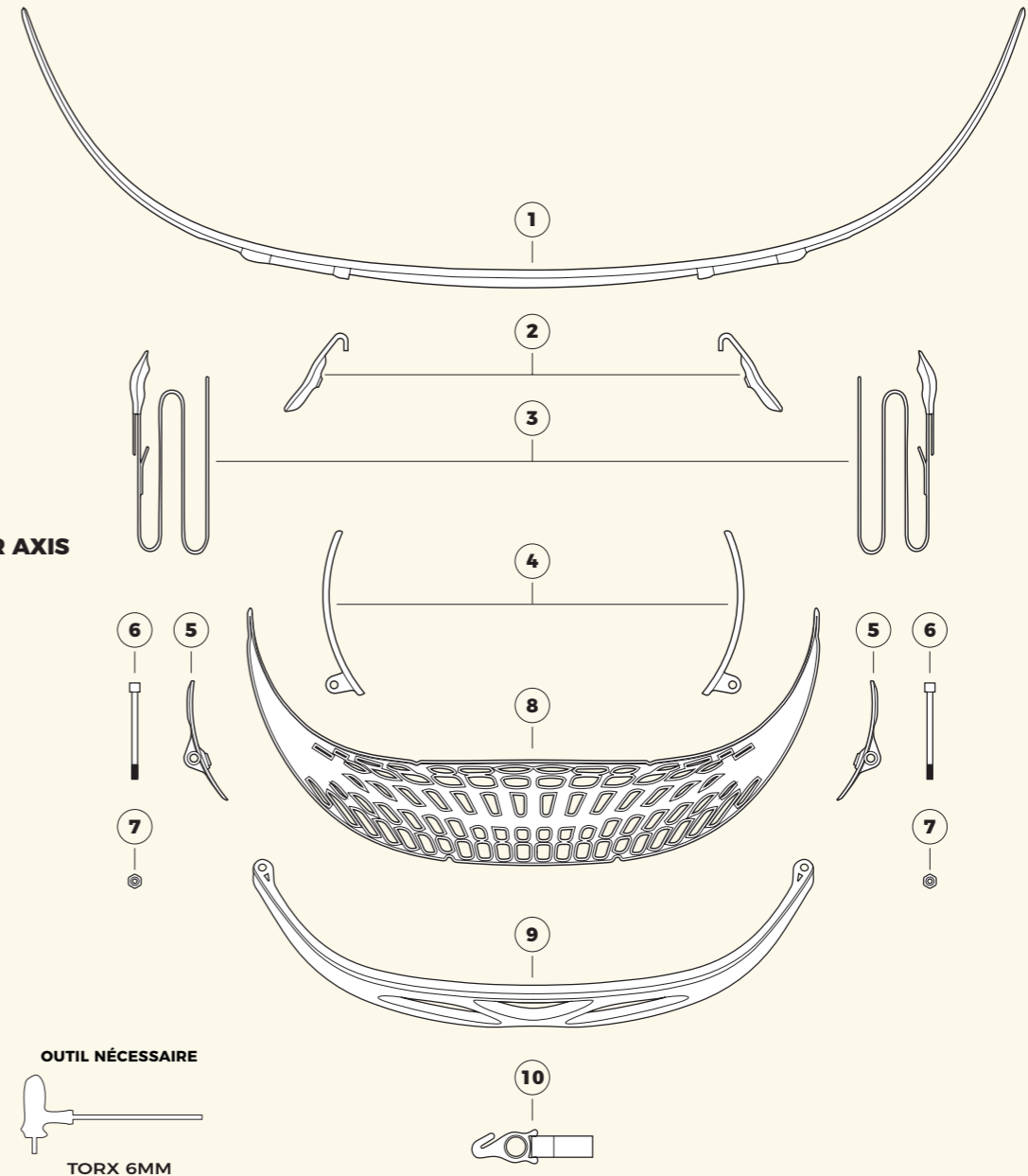

OUTIL NÉCESSAIRE

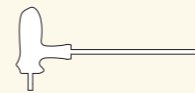

TORX 6MM



# SPARE PARTS

HARNAIS HALO

## Comment démonter le Halo.

**1** DÉ-SCRATCHEZ LE PIVOT INTER QUI SE TROUVE SOUS LE FLAP NÉOPRÈNE.

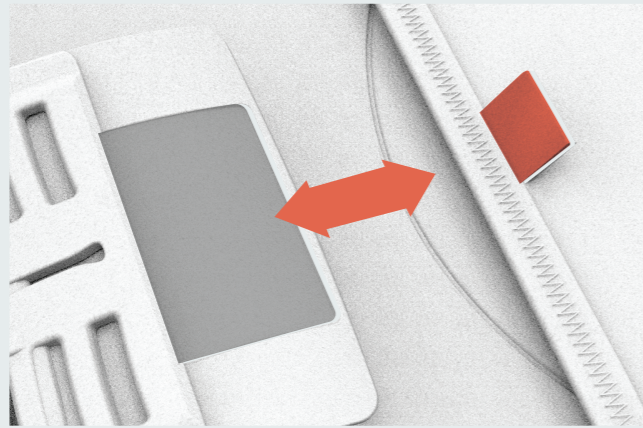

**2** SÉPAREZ LA PARTIE NÉOPRÈNE DE LA PARTIE RIGIDE.

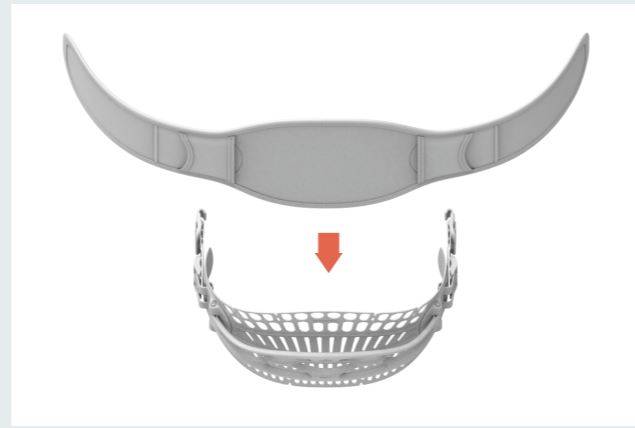

**3** FAITES GLISSER LES SANGLES HORS DES BOUCLES D'ATTACHE.

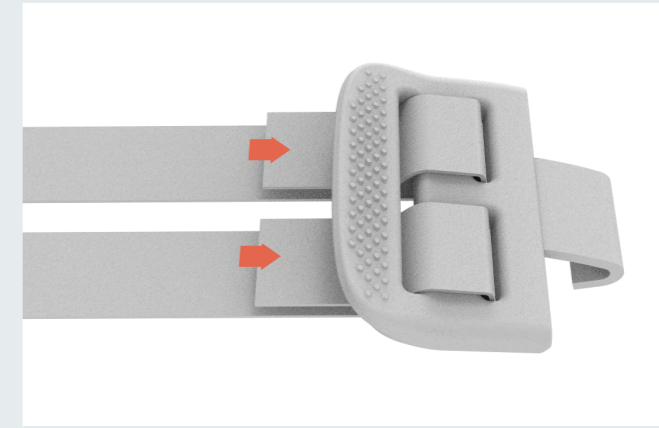

**4** FAITES GLISSER LES SANGLES HORS DES BOUCLES D'ATTACHE.

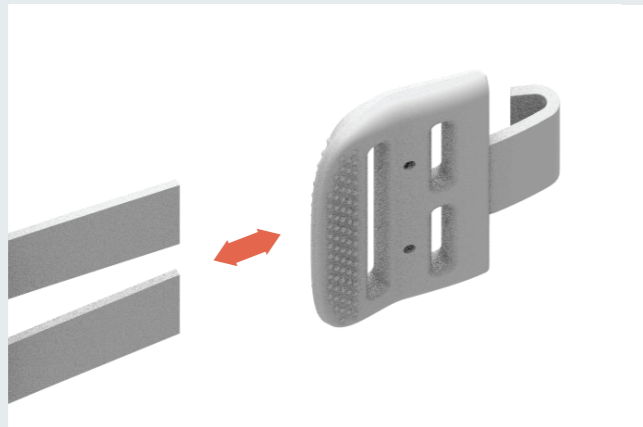

**5** FAITES GLISSER LES SANGLES HORS DE L'ADAPTIVE SKIN.

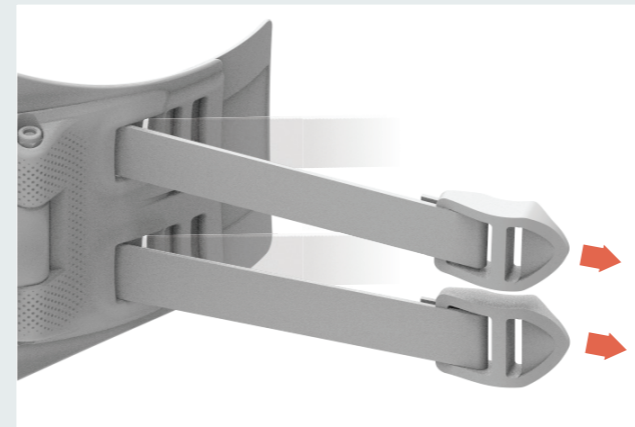

**6** DÉVISSEZ L'AXE EN INOX.

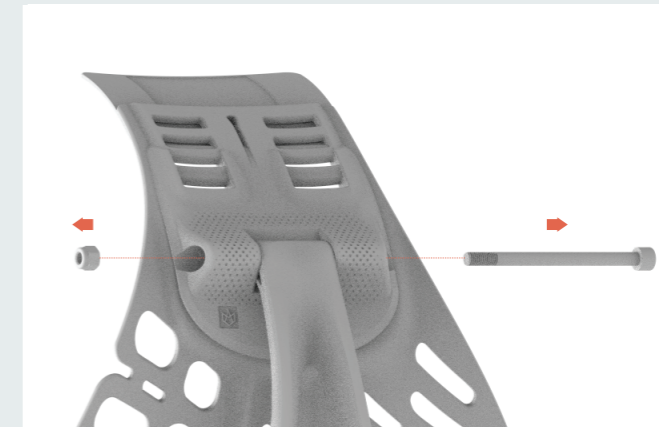

**7** SÉPAREZ LES DIFFÉRENTES PARTIES.

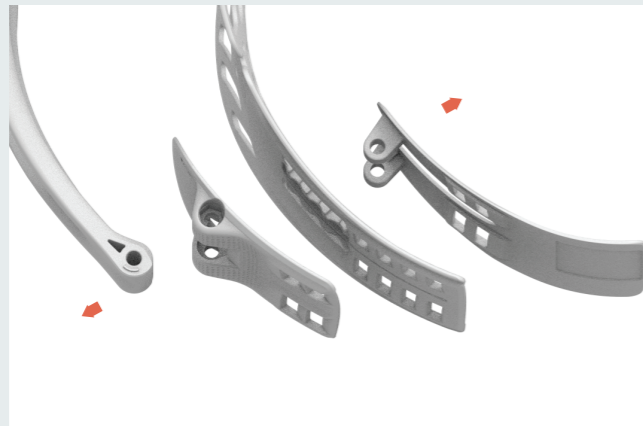

**8** CHANGEZ LA PIÈCE À REMPLACER.





# SPREADERBAR

HARNAIS HALO

## Composants.

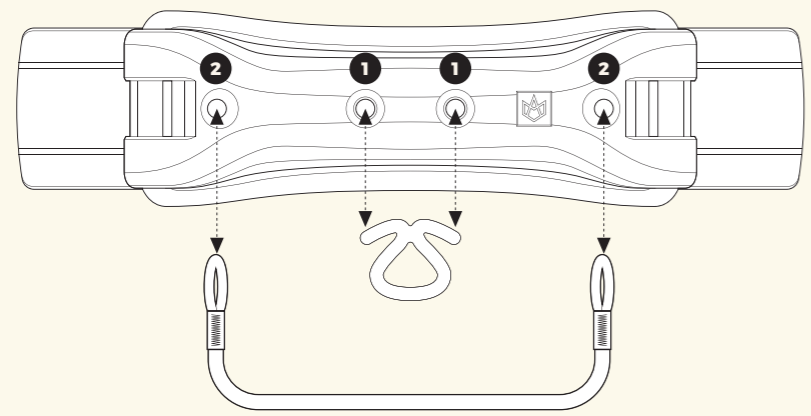
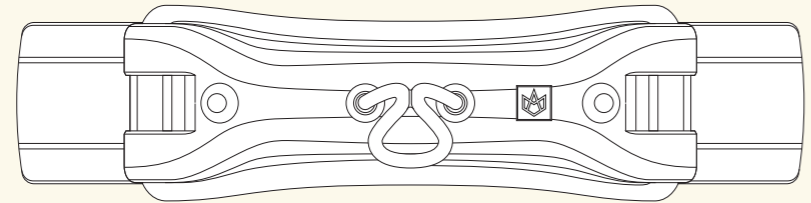

**1** TROU CROCHET    **2** TROU CORDE

**!** ATTENTION : UTILISER LES TROUS ADAPTÉS

- 1** SST SCREWS
- 2** ERGONOMIC FOAM
- 3** FLAT SCREW
- 4** M6 NUT
- 5** SST WASHER
- 6** SPREADER ARC
- 7** HOOK
- 8** SLIDING ROPE

OUTILS NÉCESSAIRES

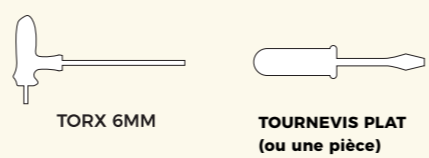

TORX 6MM

TOURNEVIS PLAT  
(ou une pièce)

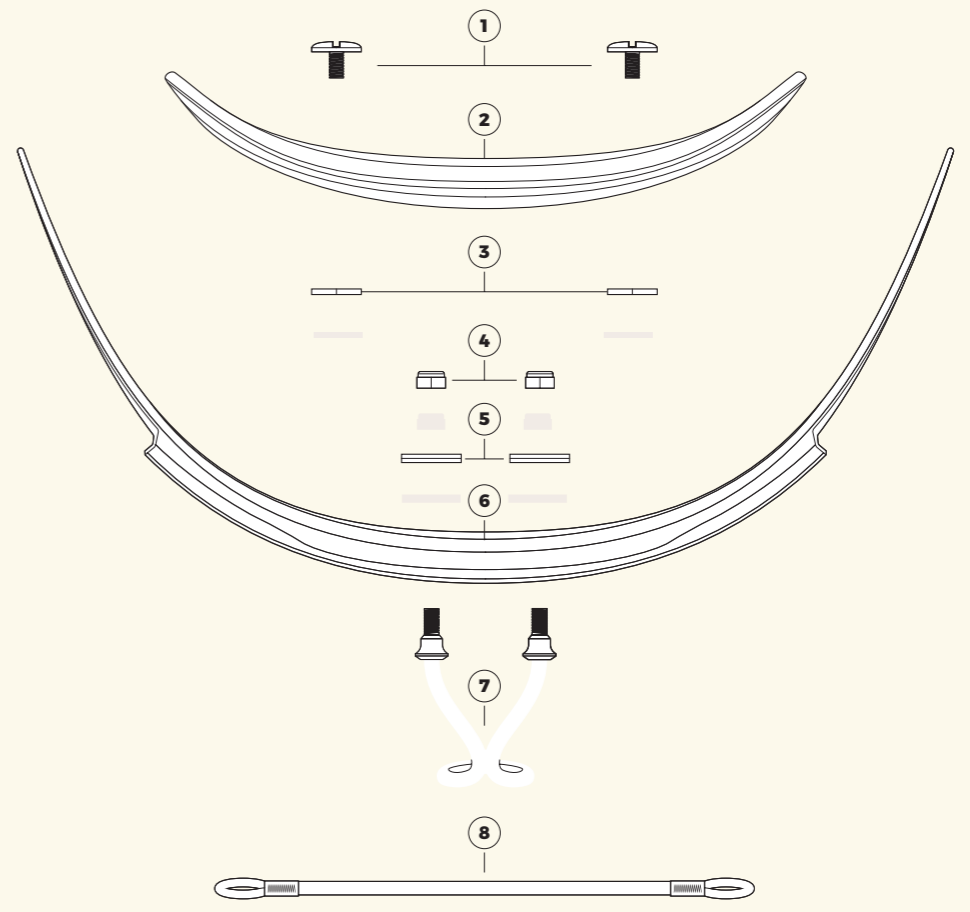



# SPREADERBAR

HALO HARNAIS

## Comment démonter le Halo.

**1** UNSCREW SST SCREWS(1), THEN REMOVE FOAM(2)

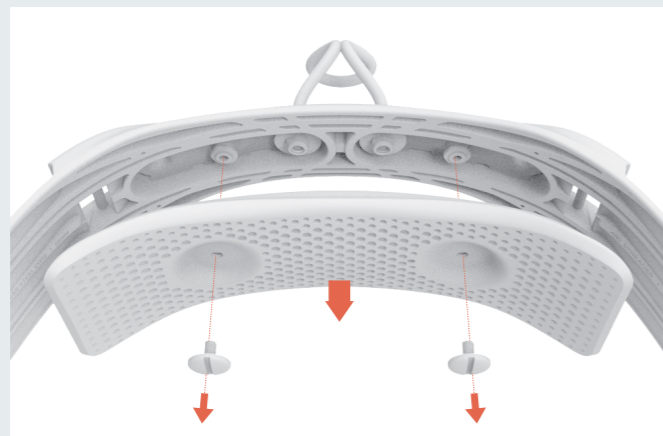

**2** UNSCREW NUTS(4), THEN REMOVE HOOK(7)

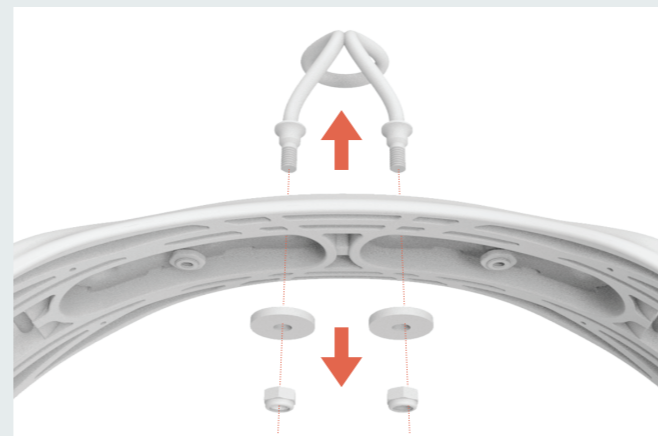

**3** PASS THE ADAPTED ROPE(8) THROUGH THE SPREADER



**4** PASS LOOPS AROUND FLATSCREWS(3)

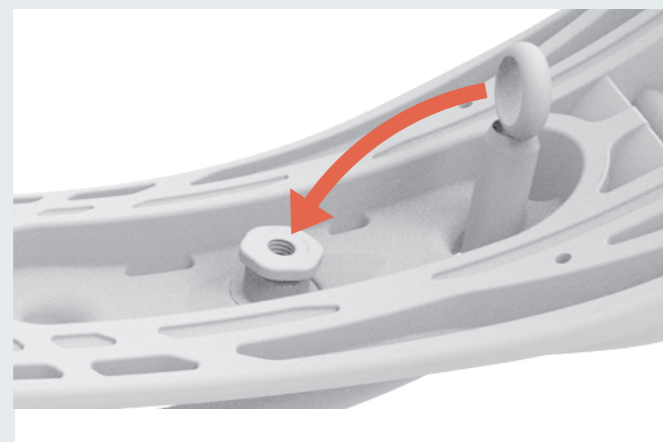

**5** UNSCREW FLATSCREWS(3) IF NEEDED

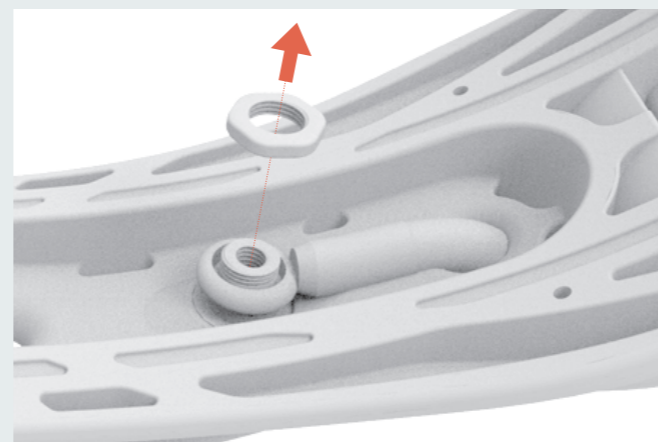

**6** THEN SCREW FLATSCREW(3) TO LOCK THE ROPE(8)

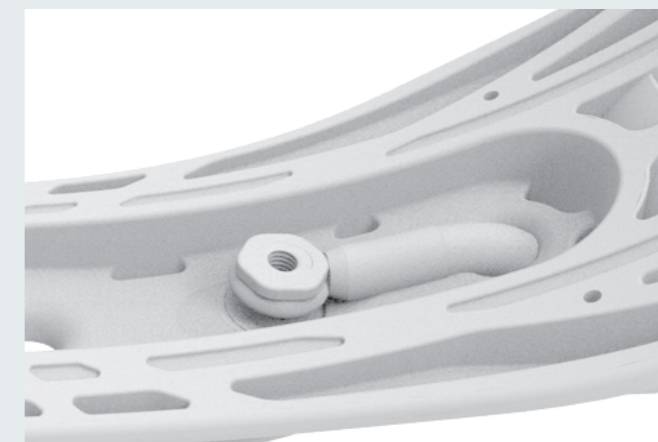

**7** SCREW SST SCREWS(1), WITH THE FOAM(2)

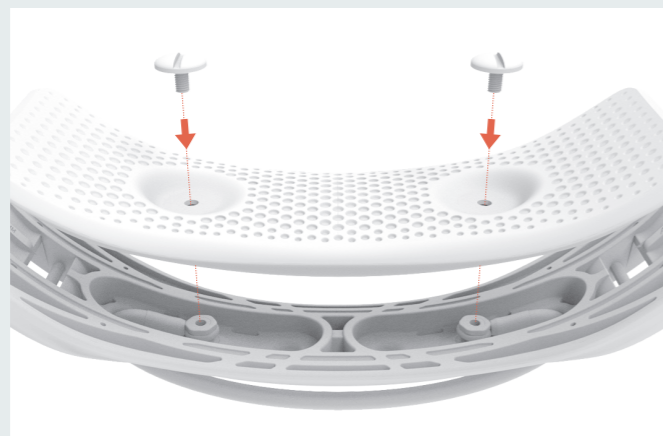

**8** CHECK EVERYTHING IS LOCKED



**9** ENJOY



# SIZECHART

HALO

## Harnais & spreaderbar.

**NOTRE LONGUE EXPÉRIENCE DANS LA FABRICATION DE HARNAIS NOUS A PERMIS DE DÉVELOPPER DES TAILLES DU HALO AJUSTÉES.**

Dans le but d'optimiser l'expérience client, nous avons ajouté deux tailles : S+ et M+. Ces deux nouvelles tailles sont en fait les harnais S et M standards équipés avec des spreaderbars plus longues.

### Pourquoi ?

Le corps peut prendre différentes formes :

- Une forme plus arrondie (quelqu'un avec un ventre prononcé)
- Une forme plus ovale (quelqu'un avec de larges hanches).

Pour le même tour de taille, nous avons donc deux morphologies complètement différentes. En intégrant des spreaderbars plus longues, les tailles S+ et M+ s'adressent plutôt à des gens aux hanches larges.

RIDER	<sup>1</sup> TOUR DE TAILLE	HARNAIS	<sup>2</sup> LARGEUR TAILLE	SPREADER
<b>XXS</b>	<b>62-70</b>	XXS	<b>24-27</b>	24
<b>XS</b>	<b>68-76</b>	XS	<b>24-27</b>	24
<b>S</b>	<b>74-82</b>	S	<b>24-27</b>	24
<b>S+</b>	<b>77-85</b>	S	<b>28-30</b>	28
<b>M</b>	<b>82-90</b>	M	<b>28-30</b>	28
<b>M+</b>	<b>85-93</b>	M	<b>31-34</b>	32
<b>L</b>	<b>88-96</b>	L	<b>31-34</b>	32
<b>XL</b>	<b>94-104</b>	XL	<b>31-34</b>	32
<b>XXL</b>	<b>102-114</b>	XXL	<b>31-34</b>	32

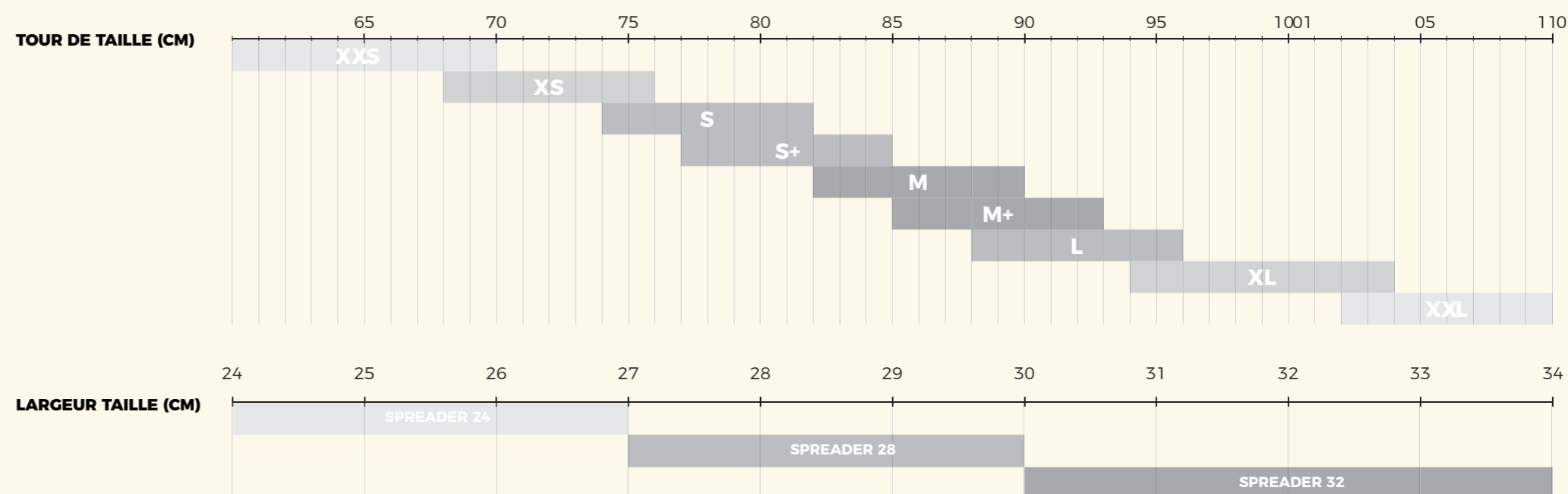
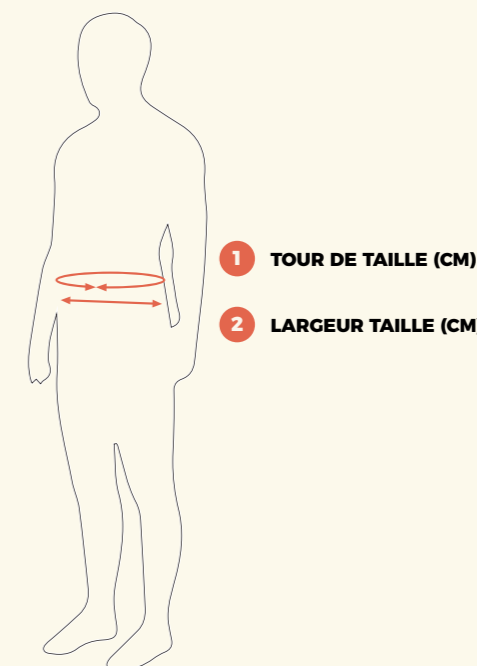



# ACCESSOIRES

HALO HARNAIS

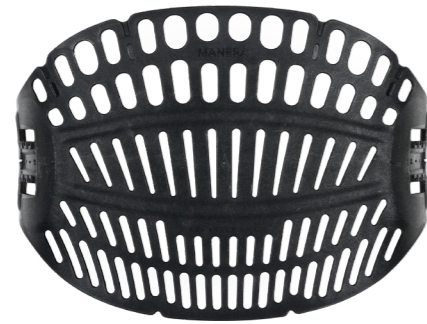

HALO **ADAPTIVE SKIN**

**DETAILS**

REF.	22222-5004
TAILLES.	XS-S-M-L-XL
COULEURS.	BLACK



HALO **HARDSHELL**

**DETAILS**

REF.	22222-5004
TAILLES.	XS-S-M-L-XL
COULEURS.	BLACK



HALO **SOFT SPAREPART**  
(x1)

**DETAILS**

REF.	22222-5003
TAILLES.	UNIQUE
COULEURS.	BLACK



HALO **STRAP**  
& **PLASTIC BUCKLE**

**DETAILS**

REF.	22222-5007
TAILLES.	UNIQUE
COLORS.	BLACK



HALO **PIVOT INTER** (x1)

**DETAILS**

REF.	22222-5006
TAILLES.	UNIQUE
COULEURS.	BLACK



HALO **PIVOT EXTER** (x1)

**DETAILS**

REF.	22222-5006
TAILLES.	UNIQUE
COULEURS.	BLACK



HALO **M5 SCREW**  
& **M5 NUT FOR AXIS**

**DETAILS**

REF.	22222-5008
TAILLES.	UNIQUE
COULEURS.	SST



KITE **KNIFE**

**DETAILS**

REF.	22232-5001
TAILLES.	UNIQUE
COULEURS.	RED



ARC **SPREADERBAR**

**DETAILS**

REF.	22232-4001
TAILLES.	24CM - 28CM - 32CM (XS-S) - (M-L) - (XL-XXL)
COULEURS.	BLACK



ARC **SLIDING ROPE**

**DETAILS**

REF.	22232-4002
TAILLES.	24CM - 28CM - 32CM (XS-S) - (M-L) - (XL-XXL)
COULEURS.	BLACK



ARC **SST HOOK** (x1)

**DETAILS**

REF.	22232-4003
TAILLES.	UNIQUE
COULEURS.	SST



ARC **BUCKLES** (x2)

**DETAILS**

REF.	22232-4004
TAILLES.	UNIQUE
COULEURS.	BLACK



*Halo*

Everything without anything





**F-ONE SAS**

ZAC de la Méditerranée  
170, Route de la Foire  
34470 PÉROLS - FRANCE

Tél. +33 (0) 4 67 99 51 16  
Fax. +33 (0) 4 67 99 61 93  
[WWW.MANERA.COM](http://WWW.MANERA.COM)

